

## Design of Feedback Controller for Boost Converter Using Optimization Technique

G. Seshagiri Rao\*, S. Raghu\*\*, N. Rajasekaran\*\*\*

\* Department of Electrical Engineering, Marwadi Education Foundation Group of Institution, Rajkot, India.

\*\* Department of Electrical Engineering, Marwadi Education Foundation Group of Institution, Rajkot, India.

\*\*\* Department of Electrical Engineering, VIT University, Vellore, India.

---

### Article Info

#### Article history:

Received Nov 1, 2012

Revised Jan 24, 2013

Accepted Feb 8, 2013

---

#### Keyword:

BFOA

Boost converter

Genetic Algorithm

MATLAB/SIMULINK

Ziegler-Nichols

---

### ABSTRACT

In this paper a new method of controller design for boost type dc-dc converter is proposed. A feedback controller for DC-DC boost converter is designed to obtain constant output voltage of 24v. The optimal values of feedback controller is obtained using Genetic Algorithm (GA). Design equations are derived and it is modeled in MATLAB. Extensive simulation is carried out with linear controller parameters and the results are presented. To compare the output of the GA based design and BFOA, the controller parameters are also determined using conventional method (Z-N). Simulation results are validated through hardware results.

Copyright © 2013 Institute of Advanced Engineering and Science.  
All rights reserved.

---

### Corresponding Author:

G. Seshagiri Rao,

Department of Electrical Engineering,

Marwadi Education Foundation Group of Institutions,

Gauridad, Rajkot 360003, India.

Email: seshu.galam@gmail.com

---

## 1. INTRODUCTION

DC-DC converters are operated in BUCK, BOOST and BUCK-BOOST at different voltage conversion ratios. Boost converters are used to obtain higher output voltage in comparison with the input DC voltage and it is increasingly employed as front end converters for battery sources, photovoltaic solar systems and fuel cells [1-3]. These converters, when operated under open loop condition, it exhibits poor voltage regulation and unsatisfactory dynamic response, and hence, this converter is generally provided with closed loop control for output voltage regulation [4]. The mode of operation of the converter varies from ON to OFF state of the power switch and traditionally small signal linearization techniques have largely been employed for controller design. Many control strategies have been proposed switch ON and OFF (duty cycle) is controlled to obtain the desired output voltage. In past, closed loop control design was carried out using small signal linearization. Linear PID and PI controllers are usually used DC-DC converters are designed using standard frequency response techniques based on small signal model of the converter. The design based on linear control theory such as Ziegler-Nichol's method [5], root locus technique [6], circle based criterion [7], hysteresis method [8], bode plot, etc. These control strategies that are based on the linearized small signal model of the converter have good performance around the operating point. However, a boost converter's small signal model changes when the operating point varies. The poles and a right-half-plane zero, as well as the magnitude of the frequency response, are all dependent on the duty cycle. Therefore, it is difficult for the PID controller to respect well to changes in operating point, and they exhibit poor performance when the system is subjected of large load variations.

Many PID tuning methods are introduced. The Ziegler-Nichols method is an experimental one that is widely used, despite the requirement of a step input application with stopped process. One of disadvantage on this method is the necessary of the prior knowledge regarding plant model. Once tuned the controller by Ziegler-Nichols method a good but not optimum system response will be reached. The transient response can be even worse if the plant dynamic changes. It must be noticed that a great amount of plants has time-varying dynamics due to external/environmental causes, e.g. temperature and pressure. To assure an environmentally independent good performance, the controller must be able to adapt the changes of plant dynamic characteristics. Recently non-linear control technique such as fuzzy logic approach [9-10] and sliding mode control are reported to give excellent static and dynamic response.

In this paper we apply optimization techniques for the feedback controller design for DC-DC boost converter. The design of feedback control parameters is framed as an optimization task and the controller parameters are identified using Genetic Algorithm (GA) and Bacterial Foraging Algorithm (BFOA). Because of its convergence to global optimum, BFOA have largely been employed for solving complex problems. However, GA has received great attention in control system such as the search of optimal PID controller parameters [11-12].

An appropriate fitness function is then derived for above objective and is used in the evolutionary optimization. The attributes of the large signal model of the power converters together with that of evolutionary algorithm yield a robust feedback controller which rejects internal and external disturbances. The designed controller using optimization technique is expected to provide excellent static and dynamic characteristics at all operating points [13]. Simulation results are verified through measured results.

**2. PROBLEM FORMULATION**

**2.1. MODELING OF DC-DC BOOST CONVERTER**

A closed-loop boost converter using a MOSFET as a switching element is show in figure 1. The specifications of the converter considered in this paper are the following: input voltage,  $V_{in}=12v$ ; switching frequency,  $F_s=10KHz$ ; Inductance  $L=750\mu H$ ; the ESR inductor,  $r_L=2\Omega$ ; capacitor,  $C=100\mu F$ ; equivalent resistance of the capacitor,  $r_c=0.5\Omega$ , and load resistance,  $R_L=120\Omega$ .

An analog PID controller is designed and the complete hardware schematic is presented in figure 1. In the closed loop control, first the actual voltage  $V_{(actual)t}$  is compared with reference voltage ( $V_{ref}$ ), this generates error  $e(t)$ , the error obtained is processed in PID controller and suitable reference is generated at the output. The output of PID controller i.e. reference is compared with ramp to generate gate pulses. The gate pulses alter the duty cycle of the MOSFET there by controlling the output voltage.

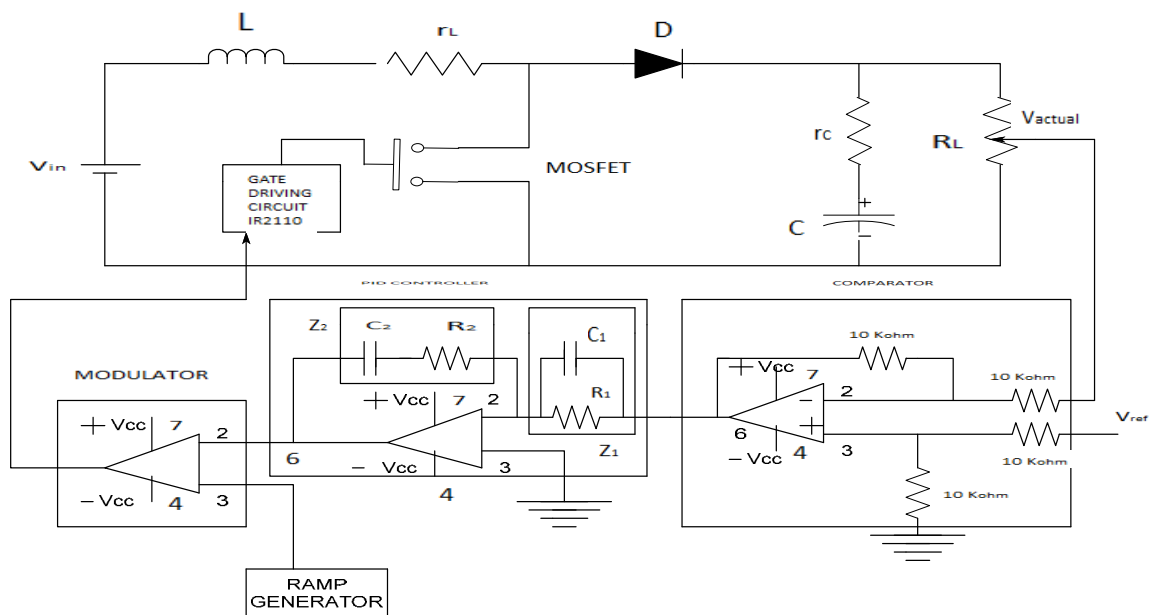

Figure 1. Hardware implementation of closed loop boost converter

## 2.2. Modeling of boost converter using state space

The state space equations describing the ON and OFF periods of MOSFET is detailed below. Equation (1) represents the ON state of the MOSFET and the capacitor voltage appears across the output. The inductor current freewheels through the switch. The converter behaviour during the ON state of the MOSFET switch is given by the differential equation (1)

$$\frac{d}{dt} \begin{bmatrix} i_L \\ v_C \end{bmatrix} = \begin{bmatrix} \frac{r_L}{L} & 0 \\ 0 & \frac{-1}{C(R_L + r_c)} \end{bmatrix} \begin{bmatrix} i_L \\ v_C \end{bmatrix} + \begin{bmatrix} \frac{1}{L} \\ 0 \end{bmatrix} V_{in} \quad (1)$$

The ON-state of the output voltage for boost converter

$$V_0 = \begin{bmatrix} 0 & \frac{R_L}{(R_L + r_c)} \end{bmatrix} \begin{bmatrix} i_L \\ v_C \end{bmatrix} \quad (2)$$

During the OFF state of the switch the load is connected to the source ( $V_{dc}$ ) and the differential equation describing this mode is given by,

$$\frac{d}{dt} \begin{bmatrix} i_L \\ v_C \end{bmatrix} = \begin{bmatrix} -\left(\frac{r_L + R_L \parallel r_c}{L}\right) & -\frac{R_L}{L(R_L + r_c)} \\ \frac{R_L}{(R_L + r_c)C} & \frac{-1}{C(R_L + r_c)} \end{bmatrix} \begin{bmatrix} i_L \\ v_C \end{bmatrix} + \begin{bmatrix} \frac{1}{L} \\ 0 \end{bmatrix} V_{in} \quad (3)$$

The output voltage for OFF mode condition is

$$v_0 = \begin{bmatrix} r_c \parallel R_L & \frac{R_L}{(R_L + r_c)} \end{bmatrix} \begin{bmatrix} i_L \\ v_C \end{bmatrix} \quad (4)$$

The above equations are modelled using matlab/simulink this model is used to assess the dynamic performance of the DC-DC boost converter.

## 2.3. PROBLEM FORMULATION OF OPTIMIZATION TECHNIQUES

In this work, more emphasis is given for improving the dynamic response of the DC-DC boost by identifying proper controller parameter. The following dynamic parameters are considered in this work.

- i) Rise Time
- ii) Settling Time
- iii) Peak Overshoot
- iv) Steady State Error

The objective of improved dynamic response of DC-DC boost converter is perceived as an optimization task and solved. Therefore the optimization problem is formulated as [13]:

Minimize:

$$F(\phi) = ((1 + Tr) * (1 + Ts) * (1 + Ess) * (1 + Po))$$

Subject to constraints:

$$K_{P(\min)} < K_P < K_{P(\max)}$$

$$K_{I(\min)} < K_I < K_{I(\max)}$$

$$K_{d(\min)} < K_d < K_{d(\max)}$$

where:

$T_r$  = Rise time

$T_s$  = Settling time

$E_{ss}$  = Steady state error

$P_o$  = Peak over shoot

The formulated optimization problem is solved using various optimization techniques and the details are presented in below.

### 3. GA AND BFOA BASED CONTROLLER DESIGN AND STEPS

#### 3.1 GA BASED DESIG

Genetic Algorithm generates solutions to optimization problems using techniques inspired by natural evolution, such as inheritance, selection, crossover and mutation. It is a biologically inspired population based algorithm and was developed by John Holland, to understand the process of natural systems. It is widely used in scientific and engineering fields. The various steps involved are

- Initializing Population.
- Evaluation of Fitness.
- Selection of Survivors based on fitness.
- Randomly varying Individuals i.e.: CROSS-OVER & MUTATION operation on the survivors.

Step1: Initialization:

Initialize population size of 10 with each chromosome representing the values of  $k_p$ ,  $k_i$ ,  $k_d$ .

Step 2: Fitness function evaluation:

Evaluate objective function for the entire population by assigning a value to each chromosome. Arrange chromosomes of the population according to fitness values.

Step 3: Selection:

To evolve chromosome with best fitness value, chromosomes are selected and in this work roulette wheel selection is used.

Step 4: Crossover and mutation

Perform cross-over and mutation operation to evolve best chromosome values. In the present work probability of cross-over is taken as 0.2 and probability of mutation is taken as 0.7.

Step 5: Termination

Continue steps 2, 3, 4 till the stopping criteria is met or for a particular number of iteration.

A MATLAB code is involving above steps and the convergence characteristic of the GA algorithm is shown in figure 2. The algorithm converges at a value near 1.26 at the 11<sup>th</sup> iteration.

Controller parameters values obtained using GA algorithm is presented in the table below:

Table. 1. Controller gains obtained from GA

K p	K i	K d
0.7246	5.5188	0.0073

#### 3.2. BACTERIAL FORAGING ALGORITHM (BFOA) BASED FEEDBACK CONTROLLER DESIGN

Bacterial Foraging Algorithm mimics how bacteria forage over a landscape of nutrients to perform parallel non gradient optimization. This algorithm is inspired by the social foraging behavior of Escherichia Coli. The bacteria moves by taking small steps while searching for nutrients to maximize its energy, known as chemotaxis.

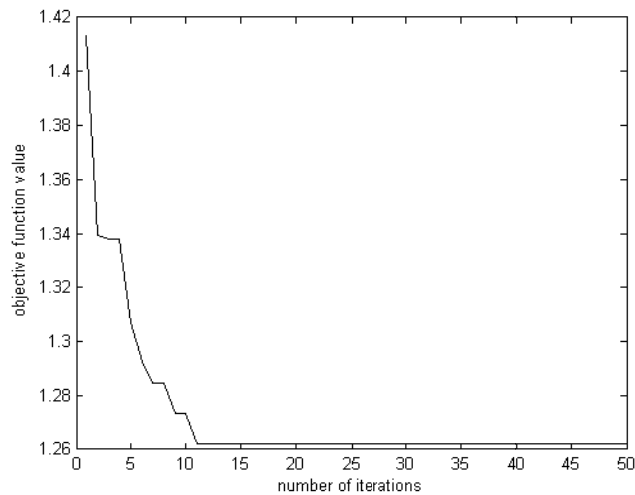

Figure 2. convergence characteristics of Genetic Algorithm

The above steps are presented in the flowchart in Figure 3.

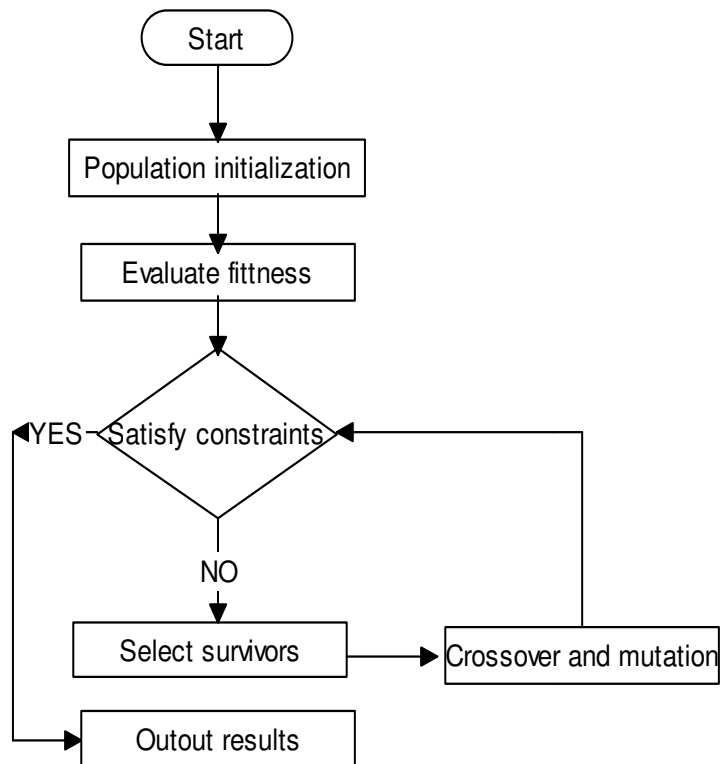

Figure 3. Flow chart of GA

The following are the steps involved in BFOA based controller design:

- **Initialization:** Generate a population of size 10 within suitable range for each  $k_p$ ,  $k_i$ ,  $k_d$ .
- **Fitness Evaluation:** Evaluate objective function for the entire population.
- **Sorting:** Arrange population according to fitness.
- **Store:** Keep a record of the Best Fitness value at the end of every iteration out of the 10 values generated to know the convergence.

- **Run & tumble:** Bacteria takes small steps in any direction in order to search for food. They take  $n$  steps in same direction till they can maximize their energy.
- **Reproduction:** Bacteria splits into two and again each individual tries to find nutrients.
- **Elimination & Dispersal:** The bottom 50% population previously obtained is now replaced by the new bacteria formed.

The above steps are repeated till the termination criteria are met. A dedicated matlab code is written for the bacterial foraging algorithm. The convergence characteristics so obtained is shown below. From the figure it can be inferred that the algorithm converges at a faster rate i.e. at the 4<sup>th</sup> iteration and the value at which it converges is around 1.271.

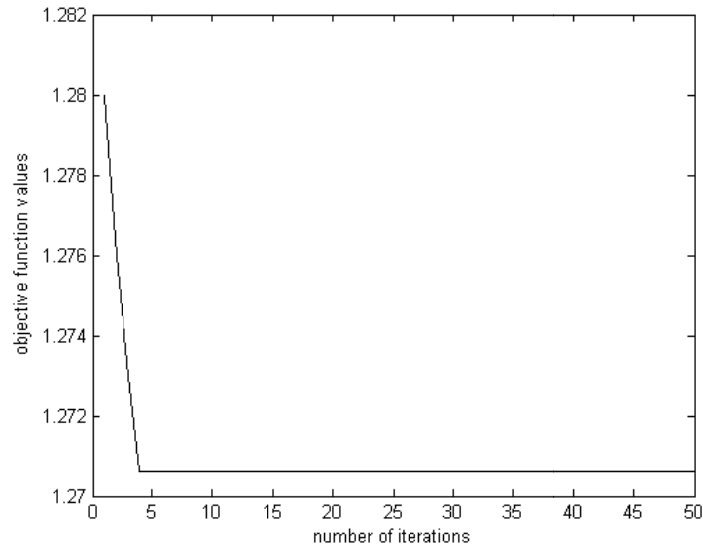

Figure 4. Convergence characteristics of BFOA

The values obtained for the controller parameters using BFOA are shown in the table 2. The flowchart corresponding of BFOA is shown in Figure 4.

Table 2. Controller gains obtained from BFOA

$K_p$	$K_i$	$K_d$
1.5851	10	0.0042

### 3.3. PERFORMANCE ASSESSMENT OF VARIOUS ALGORITHM BASED ON SYSTEM RESPONSE

With the developed MATLAB model and MATLAB code written for different algorithms, the efficacy of the proposed algorithm is assessed. Programs written for both the algorithms are made to run for different initial values and the best values are selected. Thus selected best values are substituted in MATLAB model and the dynamic response is taken. The simulated dynamic response of the closed loop DC-DC boost converter is shown in Figure 6.

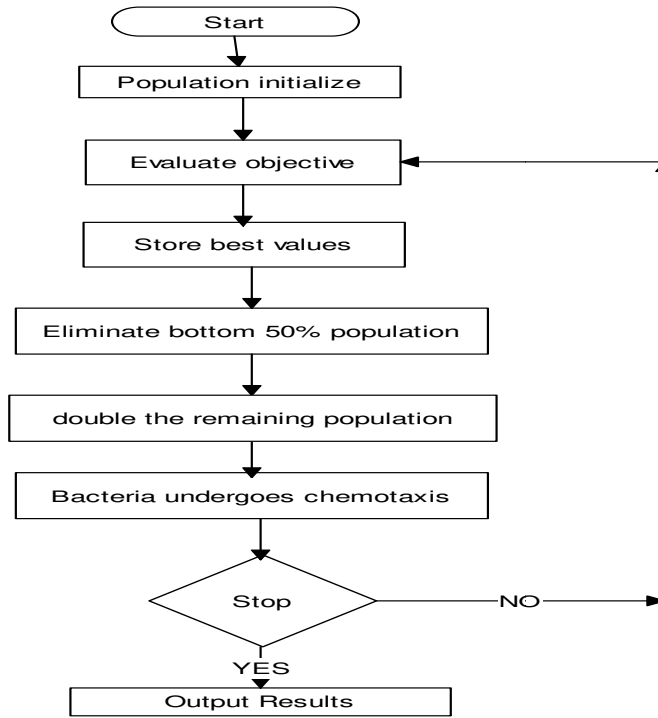
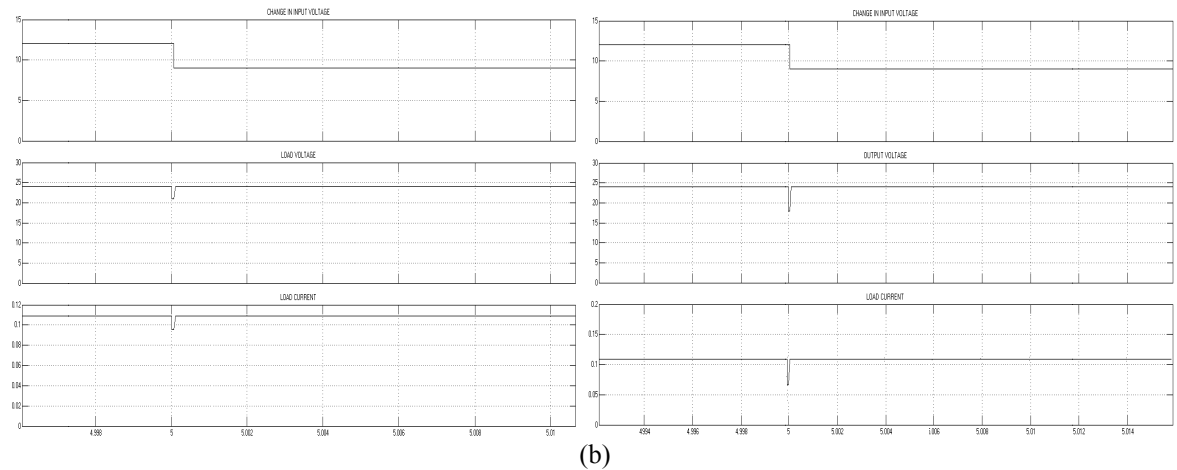
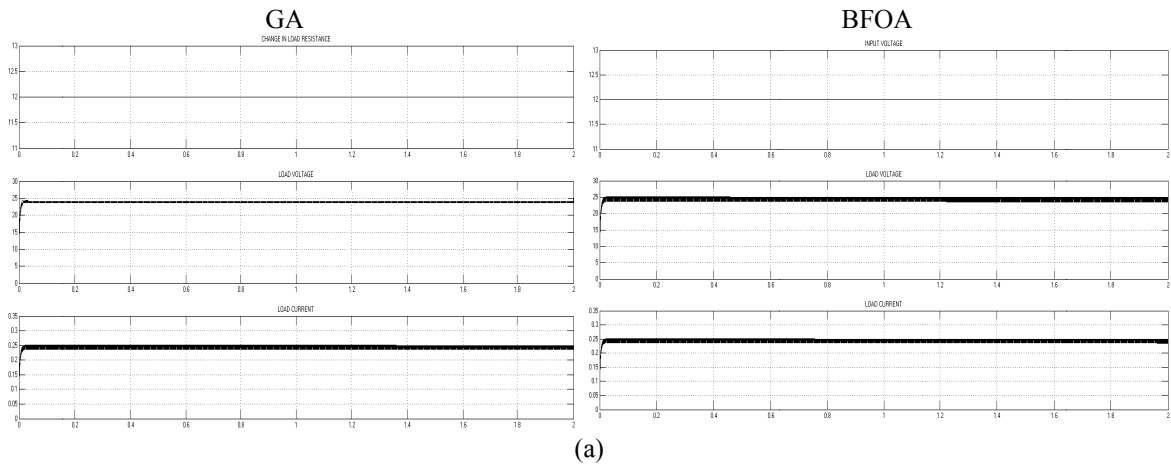
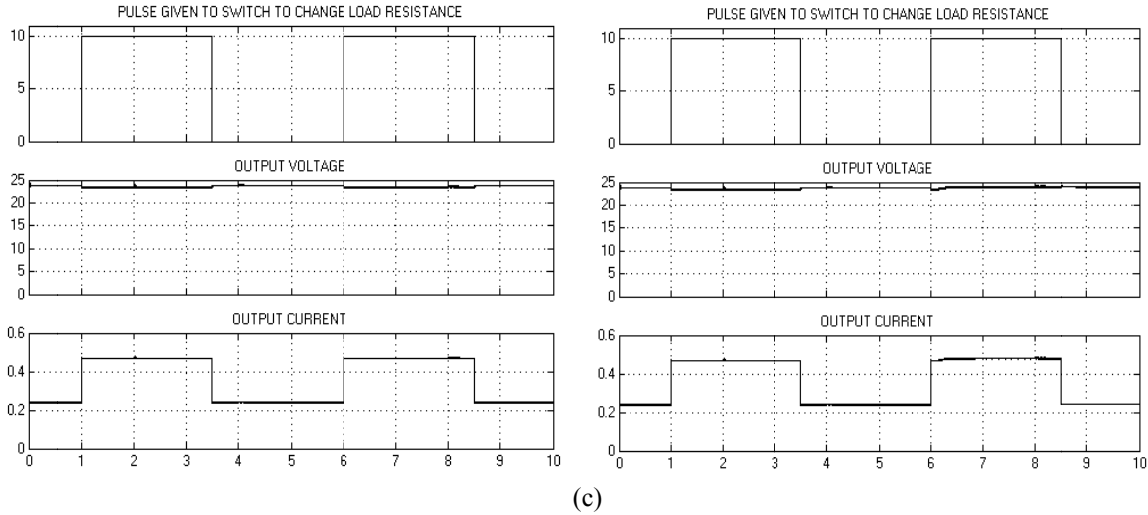
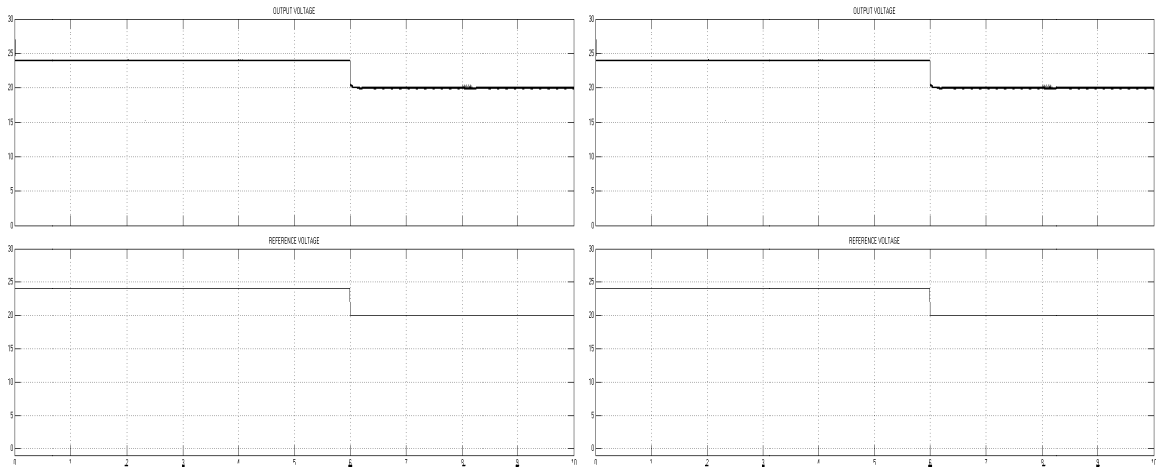

Figure 5. Flow chart of BFOA





(c)



(d)

Figure 6. The simulated dynamic response of the closed loop DC-DC boost converter  
 (a) Output voltage response of Boost converter for 12 V step input  
 (b) Output voltage response for step change in input voltage from 12V to 9V  
 (c) Output voltage response for change in load resistance from 120 Ω to 70 Ω and then back to 120 Ω  
 (d) Output voltage for change in reference voltage from 24 V to 20 V

The various dynamic response parameters found for the controller gain parameters obtained from two algorithms in the before are summarized in the table below.

Table 3 Comparison of results obtained from GA and BFOA.

Algorithm	$K_p$	$K_i$	$K_d$	Rise Time( $T_r$ )	Settling Time ( $T_s$ )	Peak Over shoot ( $P_o$ )	Steady state error ( $E_{ss}$ )
GA	0.7246	5.518	0.0073	0.0128	0.0276	0.2092	0.21%
BFOA	1.585	10	0.0042	0.0129	0.0204	0.2338	0.74%

#### 4. RESULTS AND DISCUSSIONS

From table 3 it can be inferred that, the value for rise time is almost same for the two algorithms, Settling time is comparatively less for BFOA derived values and it is maximum in the case of GA, Peak overshoot value is minimum for GA also the steady state error is small as compared to that obtained from other algorithm. The dip in output voltage of GA is 3v and 6v in case of BFOA which is quite large. The output characteristics are almost similar i.e. without any significant difference for controller values found



from all algorithms for change in load resistance. Thus it can be concluded that the controller parameter values obtained from GA are best suited for feedback PID controller design in all aspects

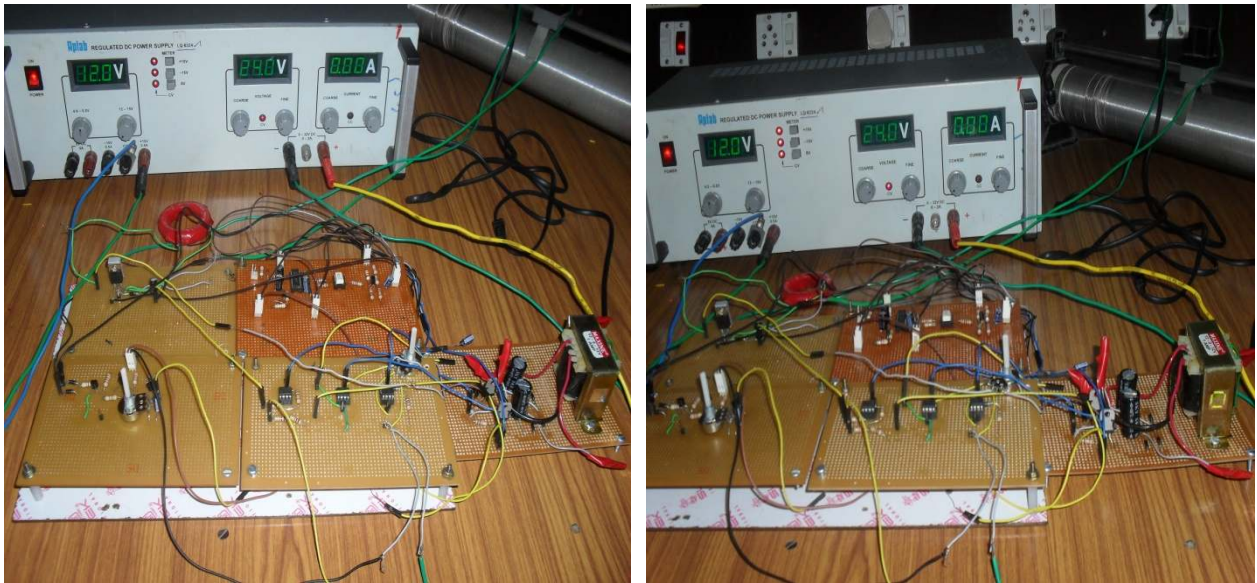
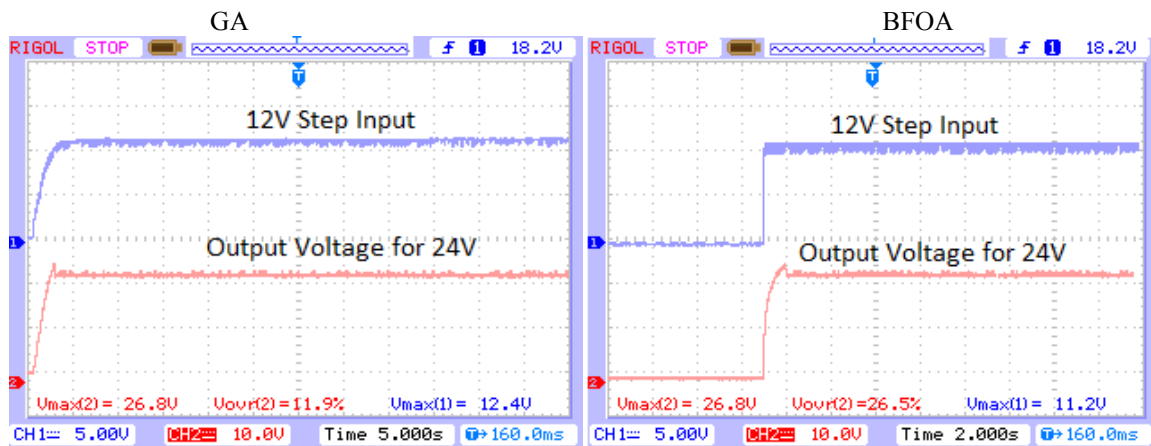
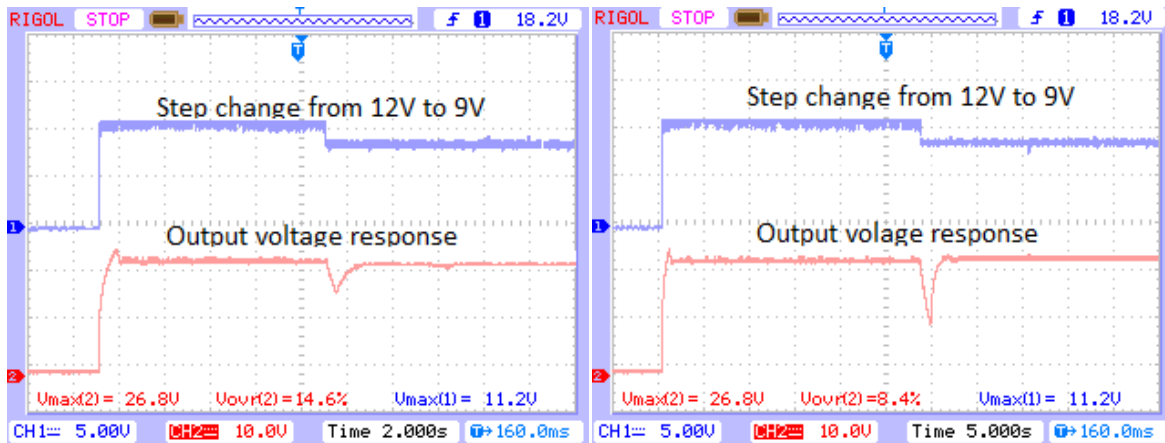

Figure 7. Hardware setup for closed loop boost converter.

To verify the simulation results a hardware prototype for the designed boost converter is fabricated in the laboratory. The developed prototype with its closed loop controller is shown in figure 7. The results taken for GA and BFOA tuned values for step change in input voltage and reference voltage is presented below shown Figure (8). The hardware results agree well with the simulated results.



(a)



(b)

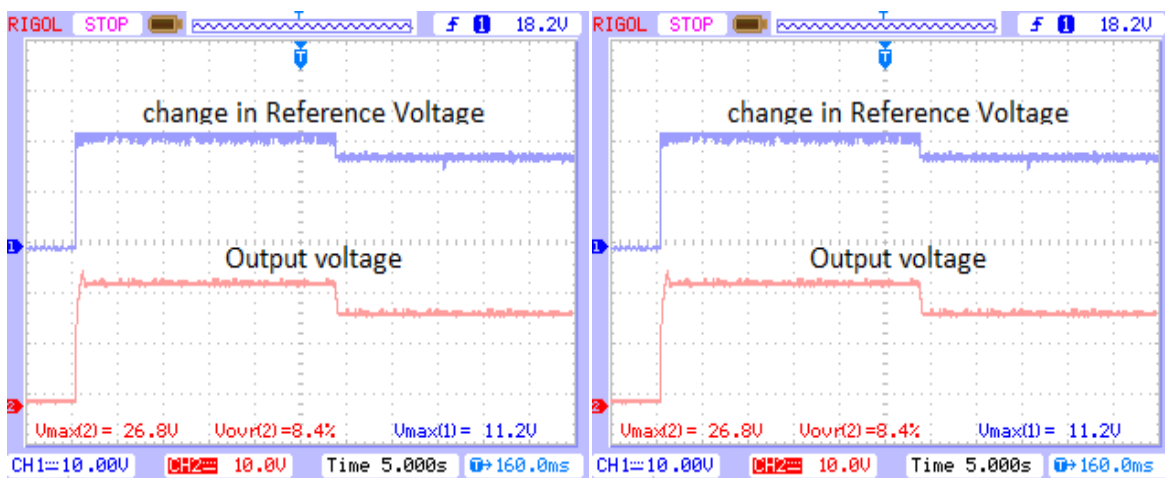

(c)

Figure 8 Measure results for closed loop output voltage  
 (a) Output voltage response of Boost converter for 12 V step input  
 (b) Output voltage response for step change in input voltage from 12V to 9V  
 (c) Output voltage for change in reference voltage from 24 V to 18 V

## 5. CONCLUSION

The design of controller for the boost converter is perceived as an optimization task and the controller constants are estimated through evolutionary search algorithms. Initially the designs of PID controller parameters for the boost converter were designed based on Genetic Algorithm (GA) and later the results are compared with BFOA. By observing the rise time, settling time, peak overshoot from the step response curves which are obtained by using the controller parameters from the comparison table it can be concluded that GA based parameter identification good and robust response compared to other methods.

## REFERENCES

- [1] Kinattungal Sundareswaran and V. T. Sreedevi, "Boost converter controller design using Queen-bee-assisted GA", *IEEE Transactions on industrial electronics*, vol. 56, no. 3, March 2009.
- [2] C. Sreekumar and Vivek Agarwal, "A Hybrid Control Algorithm For Voltage regulation in DC-DC Boost Converter," *IEEE Transactions on Electronics*, Vol. 55, no. 6, June 2008.
- [3] The design of PID Controllers using Ziegler Nichols Tuning Brain R Copeland, March, 2008.

- [4] Rick zaitu “Voltage Mode Boost Converter small Signal Control Loop Analysis Using The TPS61030”, Application Report-may 2007, Texas Instruments.
- [5] A. G. Perry, G.Feng, Y. F. Liu, and P.C. sen, “A design method for PI-like fuzzy logic controller for DC-DC converter”, *IEEE Trans. Ind. Electron*, vol. 54, no. 5. pp. 2688-2695, Oct. 2007.
- [6] B. Aldo, D. Corsanini, A. Landi, and L. sani, “Circle based Criteria for performance evaluation of controlled DC-DC switching Converters”, *IEEE Trans. Ind. Electron*, Vol. 53, no. 6, pp. 1862-1869, Dec. 2006.
- [7] Jun Zhang, Henry Shu-Hung Chung, Wai-LUN Lo, S.Y.Ron Hui, “Implementation technique For Design of switching Regulators Using Genetic Algorithm”, *IEEE Transactions on power electronics*, vol. 16, no. 6, November 2001.
- [8] J. Y. Hung, W. Gao, and J. C Hung, “variable structure control: A survey,” *IEEE Transactions. ind. electron*, vol. 40. no. 1. pp. 2-22, Feb. 1993.
- [9] Tang, K.L., and Mulholland, R J., “Comparing Fuzzy logic with clasical controller design”, *IEEE Transactions on systems, Man and cybernetics*, vol. 6. pp. 1085-1087, 1987.
- [10] R. M. Nelms, L. Guo, J. H. Hung, “Digital Controller design for Buck and Boost Converters Using Root Locus Techniue”, in *proc. 29<sup>th</sup> Annu. Conf. IEEE Ind. Electronics. Soc*, Roanoke, VA, Nov. 2-6, 2003, pp. 1864-1869.
- [11] J. F. frenzel, “Genetic Algorithms”, *IEEE potentials*, vol. 12, pp. 21-24. Oct. 1983.
- [12] Robert W. Erickson, “Fundamentals of power Electronics”, (University of Colorado, Boulder).
- [13] Ibrahim SeFA, Necmi ALTIn, Saban Ozdemir “DSPACE Based Fuzzy Lozic Controlled boost converter”, GEMEC Group, Gazi University, Akara-Turkey.

## BIIOGRAPHIES OF AUTHORS



**G. SESHAGIRI RAO** He was born in Didugu, Andhra pradesh, INDIA in 1987. He obtained the B.Tech Degree in EEE from QIS college of engineering and technology, (QIS) Ongole, Andhra pradesh, India in 2008 and the M.E degree In power electronics and Drives from VIT University, Vellore, Tamilnadu in 2012. He is presently working as Assistant Professor in Marwadi Education Foundation Group of Institution, Rajkot, Gujarat, India. He presented many research papers in various national and international conferences and journals. He presented many research papers in various national and international conferences and journals. His research interests include Power Electronics Drives and Multilevel inverters, DC–DC converters [lseshu.galam@gmail.com](mailto:lseshu.galam@gmail.com).



**S. RAGHU** He was born in Gobichettipalayam, Tamil Nadu, INDIA in 1989. He obtained the B.E Degree in EEE from Nandha engineering college (Anna University Chennai), Erode, Tamil Nadu, India in 2010 and the M.E degree In power electronics and Drives from SRM University, Chennai, Tamilnadu in 2012. Presently he is Assistant Professor in the Department of Electrical Engineering, SRM University, Kattankulathur, Chennai, India. He is presently working as Assistant Professor in Marwadi Education Foundation Group of Institution, Rajkot, Gujarat, India. He presented many research papers in various national and international conferences and journals. He presented many research papers in various national and international conferences and journals. His research interests include Power Electronics Drives and Multilevel inverters, SVPWM Techniques. [2raghu.selvaraj89@gmail.com](mailto:2raghu.selvaraj89@gmail.com).



**N. RAJASEKARAN** He was born in TAMIL NADU, INDIA. He obtained the B.E Degree from Madras University and the M.E degree In power electronics and Drives from Sastra University, tanjavur, Tamil nadu and P.hd has completed has NIT tiruchi. He is presently working as Professor in VIT university, vellore, India. He presented many research papers in various national and international conferences and journals. He presented many research papers in various national and international conferences and journals. His research interests include Power Electronics Drives and DC–DC converters.

