

Sensor Integrated Robotic Hand for Industrial Application

Om Prakash Sahu
Ritsumeikan University, Shiga, Japan
Email: om-sahu@fc.ritsumei.ac.jp

Bibhuti Bhushan Biswal
National Institute of Technology, Meghalaya, India
Email: director@nitm.ac.in

Abstract—The research work aims at developing a sensor integrated robotic hand. The broad aim is to design, model, simulate and develop an advanced robotic hand. Sensors for pick up contacts pressure, force, torque, position, surface profile shape using suitable sensing elements in a robot hand are to be introduced. The hand is a complex structure with large number of degrees of freedom and has multiple sensing capabilities apart from the associated sensing assistance from other organs. The present work is envisaged to add multiple sensors to a two-fingered robotic hand having motion capabilities and constraints similar to the human hand. There has been a good amount of research and development in this field during the last two decades. A lot remains to be explored and achieved.

Index Terms—sensor integration, intelligent robotics hand, parts identification, grasping points

I. INTRODUCTION

Robots have extensive applications in modern industries such as in inspection, materials handling, machine tending, picking and placing, palletizing, and assembling. Now a day, the production cycles are getting shorter, and the changes of industrial environments are happening everywhere. Industrial robots are usually inflexible and expensive to apply for manufacturing industries. Most of the automated robotic grippers were designed for accumulation of specific tooling systems.

The research on flexibility of industrial robotic hand or end-effector for intelligent grasping is in development stage. To increase the flexibility of intelligent robot gripper for assembling or manufacturing industries, rapid response and intelligence level play an important role. Achieving such manipulator is still a challenging task for most industrial applications. The near future intelligent assembling system should be versatile and able to adapt for any change that economizes the process. The robotic system needs to improve the perception according to the industrial environment. A lot of research has been carried out for intelligent grasping of the industrial robot in unstructured workspace.

In recent years various aspects of robotic technology has attracted many researchers. Chen et al., [1] proposed a model and algorithm for the process of mating connectors to assemble the objects in unstructured environments. Sahu, et al., presented the development of a multiple sensor integrated robot end-effector, which can be gainfully used for product assembly in industries [2]. Rad and Kalivitis [3] proposed a methodology to design and evaluate the functionality of a low-cost friction grip end-effector equipped with appropriate force and range sensors for general pick and place applications. Patle et al., explained the object recognition performance by using integration of vision and ultrasonic sensor to develop intelligent gripper [4]. Schwarz et al., [5] explained about RGB-D object detection and semantic segmentation for autonomous robot manipulation in clutter. Levine et al., described a learning-based approach to hand-eye coordination for robotic grasping from monocular images [6]. Corke and Peter [7] represented the fundamental algorithms for vision and control to assemble the assembly parts in hazardous environments. Sanchez et al., presented a survey of recent work on robot manipulation and sensing of deformable objects [8]. Jha et al., defined the grasping of unstructured manufacturing parts is considered, by using vision sensor [9]. Melikian and Hughes, explained about the industrial robot system controller with novel algorithm for assembly tasks [10]. Makris, et al. designed to make collaborative assembly systems available to workers that are not trained in programming and operating robotic systems, an intuitively applicable possibility for the system setup, information input and control has been implemented [11]. Fonseca et al. [12] presented a hand prototype with two under actuated fingers embedded with tactile feedback and a fuzzy system to obtain a stable grasp, which are integrated along with gripper.

This problem is a motivation to carry the research on identifying uncertain objects with higher accuracy. To solve this problem, robotic end-effector was integrated with sense, think, and react capabilities. To bring in sense, think and react capabilities, the industrial robot needs multiple types of sensors, control system and algorithms. This thesis provides a sensor integrated intelligent robotic hand and easy control algorithms to carry out robotic

assembly operations efficiently in unstructured environment with unique capabilities of part identification, grasping and part insertion. The objective of the proposed work is to design, model, simulate and develop a sensor integrated robotic hand with its potential application in industrial environment as well as in health-care.

A. Problem Statement

This research investigates the feasibility of development of a sensor integrated robotic hand to be used in an unstructured environment for assembly operations. It's easy to choose a robotic hand to handle one part, but problem arises for the cases where multiple parts are involved, or, where the parts are similar but of different sizes. Serious challenge lies in figuring out how a single robotic hand can handle such complex situations.

II. MATERIALS AND METHODOLOGY

This section is dedicated to enumerating the materials required for abetting this piece of research work and the technology used to achieve the objectives. The details of materials and methodology include hardware and software components essential for carrying out the proposed research work.

A. Materials

The present work is essentially an experimentally intensive research work. It requires components of two types - basic components, and augmenting components. The basic components in the present work are an i) industrial robot, ii) robotic hand, and essential peripherals to control the robot. The augmenting components are i) sensors, ii) interfaces of NI instrument, iii) control system, and iv) motor.

B. Methodology

The proposed research work aims at designing and developing a sensor integrated robotic hand, and this section presents detailed chronological steps planned for completing this work. It describes the methodology adopted for plan and use of the sensors, their selection and integration into the robot hands.

- Stage 1: Study the related literature.
- Stage 2: Formulate the research problem.
- Stage 3: Determine sensor requirements for robotic assembly in the work environment.
- Stage 4: Select the appropriate sensors.
- Stage 5: Carry out experiments with sensors to ensure their suitability for the purpose.
- Stage 6: Integrate the sensors with industrial robot.
- Stage 7: Implement the developed system for various assembly operations.

III. DATA ACQUISITION AND SYSTEM CONTROL

To collect information's of integrated sensors in real-time; all interfaced DAQ cards are connected with NI PXIe-1082 control unit, shows the scheme of sensor integration with DAQ system setup along with all incorporated sensors. In this set up the main DAQ

program of virtual instrumentation are interfaced with NI-cRIO, and connections has been deployed in the main control function. Now the acquired data of sensors are processed, using different methodologies, algorithms and calibrations, it is ready to give the intelligent command to Kawasaki robotic library to actuate the servo motors for the further movements and real-time operations in the work space. The concept of sensor integration with DAQ system is presented in Fig. 1.

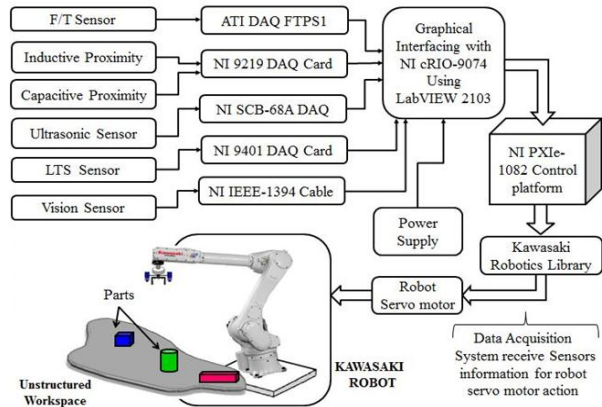

Figure 1. Scheme of sensor integration with DAQ system.

A. Control System

An intelligent robotic hand control system is usually prepared by arrangement of five key modules that execute data acquisition, part recognition, grasping point, manipulator positioning, and hand control. The grasping system can take decision intelligently and it usually comprises of sensory data acquisition module and interfaces of NI analysis module. The basic idea of control system is to design intelligent grasping robotic hand. The hand control system architecture is shown in Fig. 2.

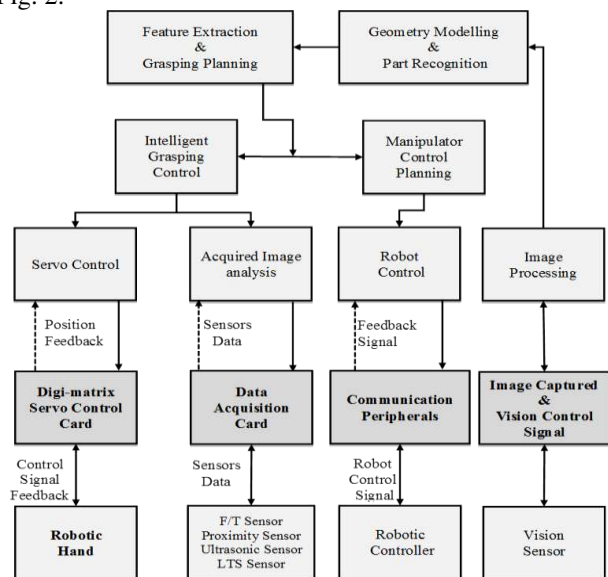

Figure 2. Control system architecture.

B. Vision System for the Robotic Hand

Vision sensor has been used for collection of visual information, which is then used for feature extraction,

and for image interpretation, part shape determination, etc. In the intelligent vision system, geometrical information and their feature extraction are significant matters to solve the problem in desired application domains. For the perfect grasping of object with the help of intelligent robot vision system, the following subjects are dealt with.

- Capturing the image
- Processing system for image
- Algorithm for part recognition
- Algorithm for grasping system

This research work concentrates on feature extraction, explanation and understanding of those structures that are important for the grasping purpose and enabling grasping arrangement. For grasping of the object, the position, orientation as well as the actual structure of objects must be identified precisely.

C. Sensor Integration and Calibration

To increase the intelligence level of proposed prototype robot hand, a sensor interfaced control system has been designed. This scheme combines the control plans along with location of sensors and their integrations. Each sensor is individually integrated and calibrated in the locations of robot hand. The schemes for the location of sensors in the robot hand is as follows

- The force/ torque sensor is mounted between the Kawasaki robot manipulator and robot hand i.e. on the location of wrist in the end-effector.
- Then the most important usable vision and ultrasonic sensors are located, on parallel position of the robot hand to observe the workspace at appropriate distance.
- The capacitive and inductive proximity sensors are located with parallel contextual position of fingers to provide the object properties and their information.
- Light touch switch (LTS) sensor is located on the both the fingers, which will directly interact with objects and provide the digital information when clasper fingers will pick or releasing the objects.

D. Testing of Individual Sensor

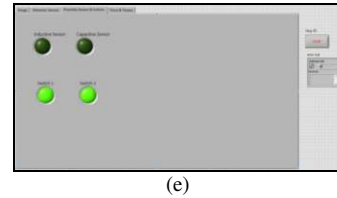
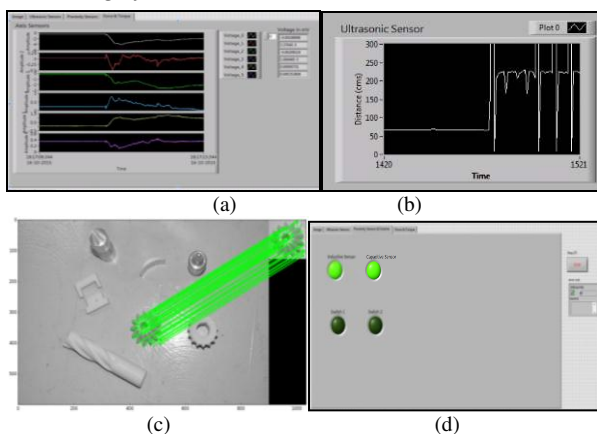

Figure 3. (a) Force/Torque sensor (b) Ultrasonic sensor (c) Vision Sensor (d) Capacitive and inductive proximity sensor responses (e) LTS Sensors responses using LabVIEW.

The output of the proposed research work is explained step by step from the beginning in this section. Testing of individual sensor has presented in Fig. 3, where tested sensors are calibrated along with acquired data to control the functional system.

IV. DESIGN AND DEVELOPMENT OF PROTOTYPE ROBOTIC HAND

The proposed robot hand design procedure has been defined as a five-stage systematic process. A set of necessities are recognized by identifying the design problem. The first stage of the design process is ‘concept design’, which includes establishing a set of specifications and design substitutes. Initially, the substitutes are modelled, simulated and estimated. In the next step, the substitutes and specifications are transferred to the fabrication process. Finally, the ‘implementation and testing’ stage involves validating the final design by testing the developed prototype structures.

A. Implementation of the System

The sensor integrated robot hand has been used for carrying out the various modules involved in abetting an assembly process. The correctness of grasping depends on the method to grip the object, finding the grasp points, and the force to be applied on objects. This section presents the applied methodologies, algorithms for grasping four different shaped objects circular, rectangular, hexagonal and unevenly shaped.

V. RESULTS AND DISCUSSIONS

This section presents the research outcomes and results along with discussions. As result, an intelligent robotic hand is designed and developed along with integrated sensors are presented.

A. Development of Integrating Platform

To arrange the all sensors an integrated platform has developed, through which the system can control in a single platform presented in Fig. 4.

B. Hand Design and Analysis in ANSYS

To analyses the designed prototype robot hand ANSYS-15 workbench has been used, where the transient structural module is used to conduct a finite element analysis (FEA). Mesh analysis of robot hand and complete FEA to determine equivalent elastic strain, equivalent stress, strain energy, total deformation, are represented in Fig. 5.

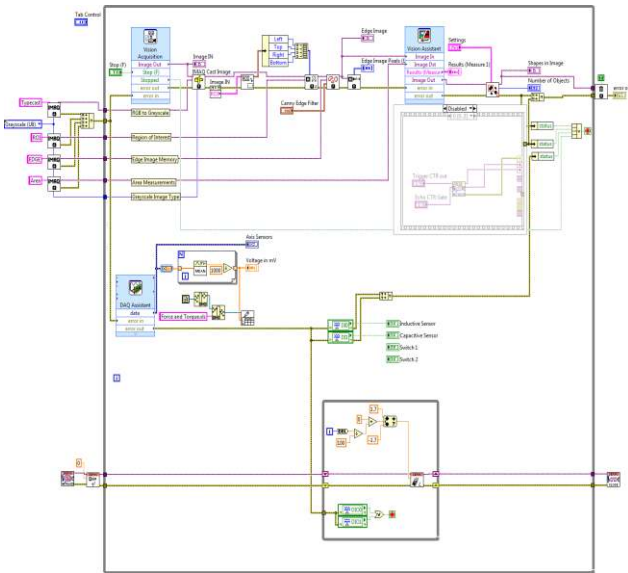

Figure 4. Circuit diagram for sensors integrated platform of Main DAQ VI.vi setup using LabVIEW.

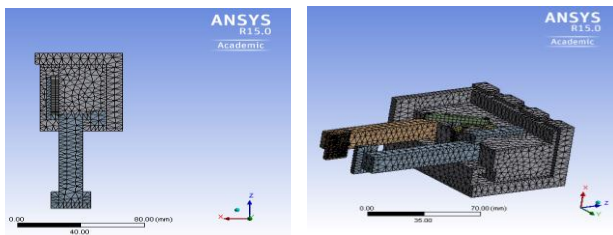

Figure 5. Mesh analysis of robotic hand.

C. Designed and Developed Robot Hand

Sensor integrated complete robot hand is shown in the Fig. 6.

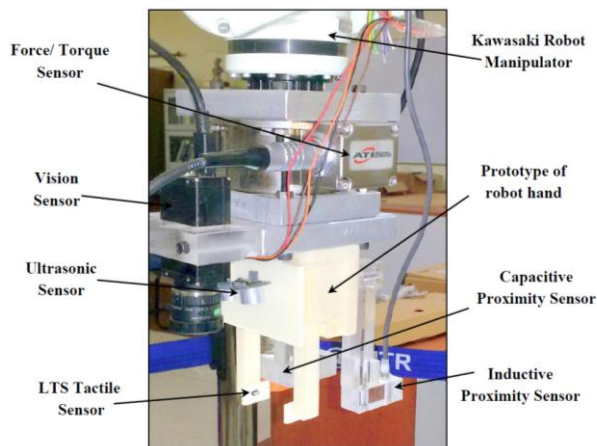

Figure 6. Sensors integrated robotic hand.

D. Grasping Points on Objects

The corners of the object are found out using the command `approxpolyDP` and are also marked with green colour. Now, the edge pixels of the image are found, and the image is divided into the pixels towards the left and pixels towards the right. Right side is used to first detect

the grasping point, as a pixel, used as reference. Then the pixel of minimum distance from the centroid on the left side and on the right side is found. These two points are the grasping points of the object. These two lines are shown in blue and red colour, as shown in Fig. 7.

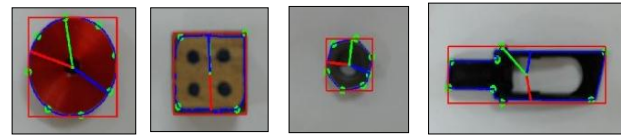

Figure 7. Grasping point of the object with two lines is shown in blue and red colour.

VI. CONCLUSIONS

In this work, an intelligent robotic hand is designed and developed by analysing, and modelling sensor data and integrating it with self-decision-making systems. In conclusion the unknown shape and size of the object can be grasped by the robotic hand is determined. The planned robotic hand system is applicable in automatic material handling and assembly operations. A sensor integrated, configurable and intelligent two-fingered robot hand for grasping is developed. This development presents a novel platform to accomplish research into automated vision system and intelligent robotic hand. The conclusion of this research which was aimed at the ‘design and development of sensor integrated intelligent robotic hand’ has been successfully reached.

CONFLICT OF INTEREST

The authors declare no conflict of interest.

AUTHOR CONTRIBUTIONS

Om Prakash Sahu composed the whole paper; Prof. Bibhuti Bhushan Biswal supervised the work; all authors had approved the final version.

REFERENCES

- [1] F. Chen, K. Sekiyama, P. Di, J. Huang, T. Fukuda, “An intelligent robotic hand for fast and accurate assembly in electronic manufacturing,” *IEEE International Conference on Robotics and Automation*, Saint Paul, pp. 1976-1981, 2012.
- [2] O. P. Sahu, B. B. Biswal, S. Mukherjee, and P. Jha, “Multiple sensor integrated robotic end-effectors for assembly,” *Procedia Technol.*, Elsevier, vol. 14, pp. 100–107, 2014.
- [3] M. T. Rad and P. Kalivitis, “Development of an autonomous friction gripper for industrial robots,” *International Scholarly and Scientific Research and Innovation*, vol. 5, no. 10, waste publication, pp. 249-255, 2011.
- [4] O. P. Sahu, B. Patle, B. B. Biswal “Part recognition using vision and ultrasonic sensor for robotic assembly system,” *IEEE Student Conference on Research and Development*, Kuala Lumpur, Malaysia, pp. 145 – 149, 2015.
- [5] M. Schwarz, A. Milan, A. Periyasamy, and S. Behnke, “RGB-D object detection and semantic segmentation for autonomous manipulation in clutter,” *The International Journal of Robotics Research*, vol. 37, no. (4-5), pp. 437-45. 2018.
- [6] S. Levine, P. Pastor, A. Krizhevsky, J. Ibarz, and D. Quillen, “Learning hand-eye coordination for robotic grasping with deep learning and large-scale data collection,” *The International Journal of Robotics Research*, vol. 37, no. 4-5, pp. 421-436, 2018.

- [7] Corke and P. Robotics, Vision and Control: Fundamental Algorithms In MATLAB® Second, Completely Revised. Springer, 2017.ch. 4.
- [8] J. Sanchez, J. Corrales, A., Bouzgarrou, and Y. Mezouar, "Robotic manipulation and sensing of deformable objects in domestic and industrial applications: A survey," *The International Journal of Robotics Research*, 2018.
- [9] O. P. Sahu, B. B. Biswal, S. Mukharjee, and P. Jha, "Development of robotic end-effector using sensors for part recognition and grasping," *Int. J. Mater. Sci. Eng.*, vol. 3, no. 1, pp. 39–43, 2015.
- [10] S. Melikian and J. Hughes, "Industrial robot system having sensor assembly," U.S. Patent No 9,862,097, 2018.
- [11] S. Makris, P. Tsarouchi, A. Matthaiakis, and S. Athanasatos, "Dual arm robot in cooperation with humans for flexible assembly," *CIRP Annals*, vol. 66, no. 1, pp. 13-16, 2018.
- [12] V. P. de Fonseca, T. E. A. de Oliveira, T. E. A., K. Eyre, and E. M. Petriu, "Stable grasping and object reorientation with a three-fingered robotic hand," in *Proc. 2017 IEEE International Symposium on Robotics and Intelligent Sensors (IRIS)*, pp. 311-317, 2017.

Copyright © 2020 by the authors. This is an open access article distributed under the Creative Commons Attribution License ([CC BY-NC-ND 4.0](https://creativecommons.org/licenses/by-nc-nd/4.0/)), which permits use, distribution and reproduction in any medium, provided that the article is properly cited, the use is non-commercial and no modifications or adaptations are made.



Om Prakash Sahu belongs from Bhilai, India and born in 1982, received the B.E. degree in electronics and telecommunication in 2005 and the M-tech. with specialization on instrumentation and control system in 2008 from the University of CSVT, Bhilai, India and he completed his PhD at National institute of technology Rourkela, India in 2017. Currently he is pursuing Postdoc at Ritsumeikan University, Japan along with

collaboration of Mitsubishi Electric and NEDO, Japan. He has been published more than 24 technical research papers at National and International levels. His areas of research interest include Sensor integration, Automatic industrial robotics, Control system and Instrumentation, Vision feedback system, Point clouds and Robot operating system.



Bibhuti Bhushan Biswal graduated in mechanical engineering from UCE, Burla, India in 1985. Subsequently he completed his M.Tech, and Ph.D. from Jadavpur University, Kolkata. He joined the Faculty of Mechanical Engineering at UCE Burla from 1986 and continued till 2004 and then joined National Institute of Technology, Rourkela as a professor and currently he is the Director of National Institute of Technology, Meghalaya, India.

He has been actively involved in various research projects and published more than 140 papers at National and International levels. His areas of research interest include industrial robotics, FMS, computer integrated manufacturing, automation, and maintenance engineering. He was a visiting professor at MSTU, Moscow and a visiting scientist at GIST, South Korea.