

Wireless Electric Vehicle Battery Charging System using PV Array

B. Sushil Kumar, S. Krithiga* and Partha Sarathi Subudhi

School of Electrical Engineering, VIT University, Vandalur-Kelambakkam Road, Chennai - 600127, Tamil Nadu, India; bompallysushil@gmail.com, krithiga.s@vit.ac.in, parthasarathi.subudhi2015@vit.ac.in

Abstract

Objectives: Wireless Power Transfer (WPT) technology is developing rapidly in Electrical Vehicle applications. Along with WPT, the benefits of Photovoltaic (PV) array are exploited and a system is proposed for extracting the power from PV array to charge the Electric Vehicle (EV) battery through Series-Series compensated network in WPT mode. **Methods/Analysis:** Recently, resonance phenomenon is widely used in transferring power efficiently to the load over a large air gap. Since, various reactive components contribute to resonance, there are many resonating frequencies. Hence, a frequency analysis of series-series compensator is carried out. The proposed system is simulated in Powersim (PSIM) software and the experimental set up has been built and tested in the laboratory. **Findings:** Frequency analysis of the proposed system helps in identifying the operating frequency at which the resonance with unity voltage gain is achieved irrespective of load variations in Series-Series wireless power transmission systems. Both simulation and experimental results are furnished in this paper for validating the proposed system. **Applications/Improvements:** As the power transfer is in wireless mode, the proposed system can be used in any climatic conditions for charging the EV. Also, closed loop controllers can be developed for improving the performance of the proposed system.

Keywords: Electric Vehicle Battery Charger, Inductive Coupled Power Transfer, Photovoltaic, Series-Series Compensation, Wireless Power Transfer

1. Introduction

Wireless Power Transfer (WPT) method can eliminate all the charging problems of Electrical Vehicles (EV)¹⁻³. Through WPT technology, Electrical Vehicle charging becomes an easy task by parking the vehicle at the charging station. Recently Inductive Coupled Power Transfer (ICPT) technology is widely used for WPT in Electrical Vehicles. ICPT consists of compensating capacitors and coupled inductor with a large air gap between them⁴.

When the inductor windings share a magnetic core, the entire flux produced by one winding gets linked with the other winding. Due to this phenomenon, tightly coupled network is used for transferring the power efficiently. Instead, if the coils do not share the magnetic core or separated with a large air gap, the flux linking the secondary coil will be very less which in turn reduces the power transfer through the coils⁵. However, these coils

can be maintained at a resonating frequency to overcome the low efficiency in WPT system. A capacitor is added on both sides of the coupled inductor to maintain the inductors at resonance. This is termed as compensation.

Since various reactive components contribute to resonance, many resonating frequencies exist in the system. Compared to other frequencies, resonant frequencies have different characteristic features. Hence, a careful study on resonant circuits at various frequencies is essential to understand the WPT system⁶.

Out of the various compensators, frequency analysis of Series-Series(SS) compensator is carried out and this compensator is chosen for the wireless power transfer. Along with WPT, PV array can be combined to provide an eco-friendly method of charging EV. PV cell converts the solar energy into electricity in a clean, reliable and quiet way without any pollution⁷⁻⁹. Hence, the PV array can be used to provide the primary source of energy for

* Author for correspondence

the WPT system. Considering all the above factors, the proposed system is designed to extract the power from PV array and convert the PV voltage into a high frequency AC voltage by means of an inverter and transfer the power to the battery charging circuit through inductive power transfer technology and rectifier.

2. Proposed SS-WPT System

The proposed Series-Series-Wireless Power Transfer (SS-WPT) system consists of a PV array, H-bridge inverter, Magnetic coupled network, a full bridge diode rectifier, a capacitive filter and a load as shown in Figure 1. The full bridge inverter which is connected to PV array converts the dc voltage to a high frequency ac voltage.

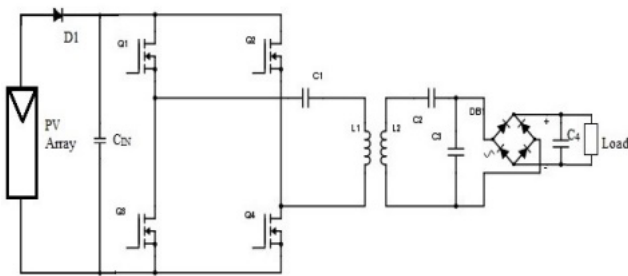

Figure 1. Series-Series compensator of WPT system.

The loosely coupled primary and secondary winding is shown as a coupled inductor with a coupling coefficient of 0.2. Capacitors, C1, C2 are connected in series with the coupled inductors to realize the SS compensator.

For obtaining the constant ac voltage signal at secondary side of coupled network, a capacitor, C3 is

connected in parallel. This constant voltage is given to diode bridge rectifier which converts constant ac voltage to desired dc voltage. This dc voltage is used to charge the EV battery of appropriate rating.

2.1 Frequency Analysis

As various inductors and capacitors contribute to resonance in compensation network, three different resonating frequencies exist. From the literature, it is found that the preferred resonant frequency can be divided into two categories: (i) resonant frequency by self-inductance and series capacitor¹⁰⁻¹⁷, and (ii) the other resonant frequency by leakage inductance and series capacitors¹⁸⁻²¹.

From the frequency analysis⁶, three different resonant frequencies are obtained as given below:

$$\omega_{01} = \frac{1}{\sqrt{L_1 C_1}} = \frac{1}{\sqrt{L_2 C_2}} \quad (1)$$

$$\omega_{02} = \frac{\omega_{01}}{\sqrt{(1-k)}} \quad (2)$$

$$\omega_{03} = \frac{\omega_{01}}{\sqrt{(1+k)}} \quad (3)$$

It was observed that at first resonant frequency (ω_{01}), the voltage gain changes with the change in quality factor. That is, if the load changes, the voltage gain also changes. But, at other two resonant frequencies (ω_{02} , ω_{03}), the voltage gain is always 1 irrespective of the load variations.

The first resonant frequency is fixed while the second

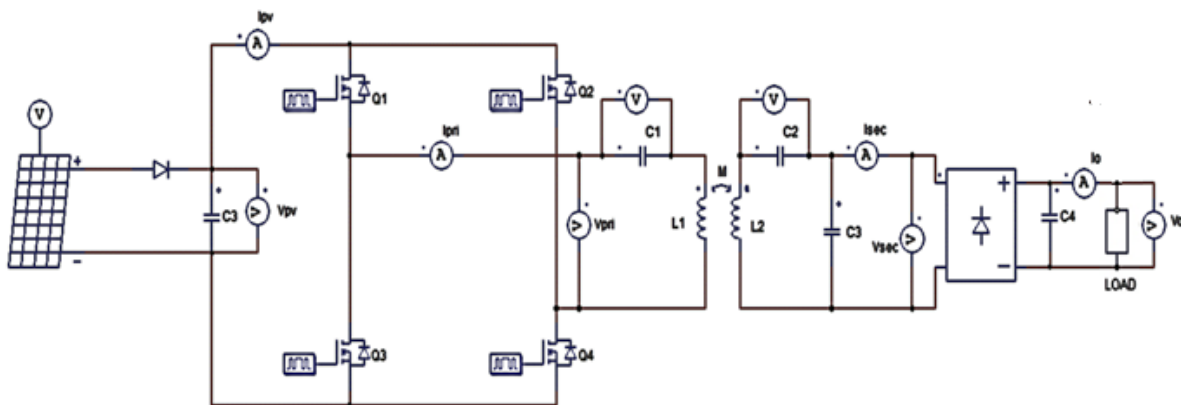

Figure 2. Simulation Model of the proposed SS-WPT System.

and third resonant frequencies are determined by the coupling co-efficient (k). As the voltage gain is always 1 at second resonant frequency, ω_{02} is preferred in power electronic applications, whereas ω_{03} is preferred in other applications⁶.

The values of the coupled inductor and the series capacitors are designed using the first resonant frequency (ω_{01}). For effective power transfer, the inverter should be operated at second resonant frequency (ω_{02}).

3. Simulation Studies and Results

The proposed SS-WPT system is modeled and simulated in PSIM software as shown in the Figure 2.

3.1 H-Bridge Inverter

H-Bridge inverter consists of four switches as shown in Figure 2. When Q_1 and Q_4 are triggered, a positive voltage will be appearing at the output and when Q_2 and Q_3 are triggered, a negative voltage will be appearing at the output terminals of the inverter. This square signal is given to magnetic coupled network also referred as resonating tank. The square wave can be defined as

$$V_{pri}(t) = V_{in} (0 < \omega t < \pi) \tag{4}$$

$$= -V_{in} (\pi < \omega t < 2\pi)$$

The operating frequency, f_{02} of inverter is chosen as 50 kHz.

3.2 Magnetic Coupled Network

The values of coupled inductors and compensating capacitors are designed as per the equations (1) & (2) with the first resonating frequency f_{01} as 45 kHz. The designed values are shown in the Table 1.

Table 1. Parameters of Coupled Network

Sl. No.	Parameters	Specifications
1	$N_1:N_2$	1:1
2	C_1, C_2	0.1 μ F
3	L_1, L_2	126.6 μ H
4	Mutual Inductance	25.3 μ H
5	Coupling Co-efficient	0.2

Using the designed values, simulation studies of the proposed system is carried out and the results are presented in this section. PV array voltage, V_{pv} and current, I_{pv} was found to be 32.4V and 3.2A respectively as shown in Figure 3.

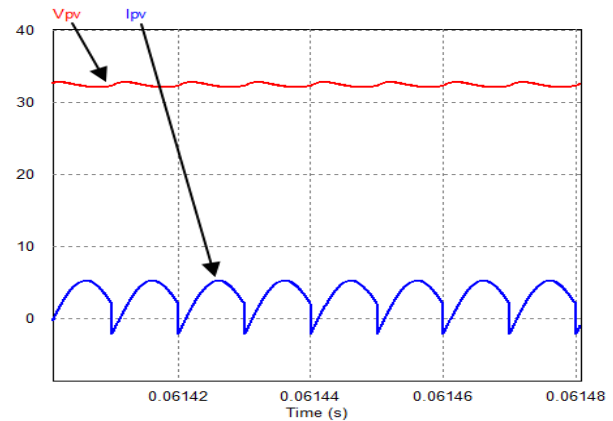

Figure 3. PV array Voltage and Current Waveforms.

The voltage waveforms of primary and secondary sides of coupled inductor are shown in the Figure 4. From the results, it was found that the voltage gain of coupling network is almost equal to 1.

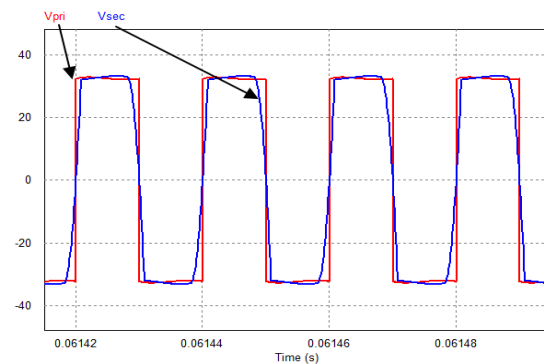

Figure 4. Simulated voltage waveforms at primary and secondary side of magnetic coupled network.

The waveforms of primary side voltage, V_{pri} and current I_{pri} , are shown in Figure 5(a). Secondary voltage V_{sec} and secondary current I_{sec} are shown in the Figure 5(b). The load voltage V_o & output current I_o are shown in Figure 5(c) which was found to be 32.7V and 3.1A respectively.

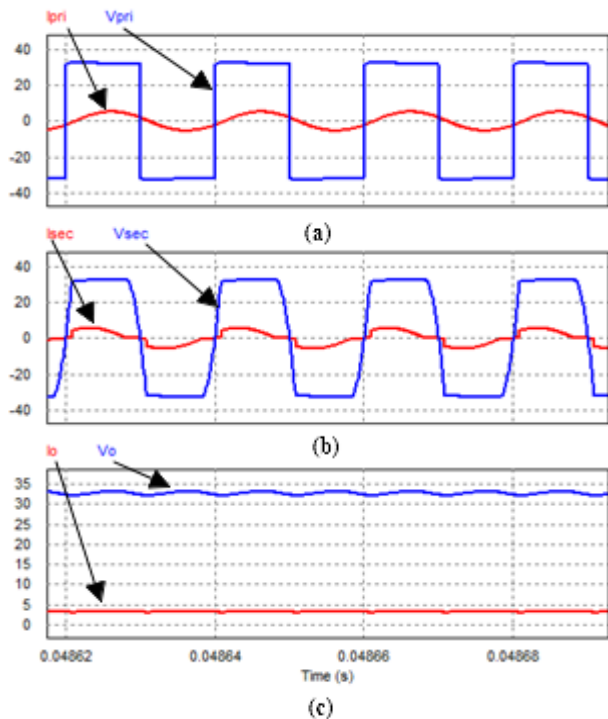

Figure 5. Voltage and Current Waveforms at (a) primary side of coupled Network, (b) Secondary side of coupled Network and (c) Load.

4. Experimental Investigation

The prototype of the proposed system is fabricated in the laboratory and the photograph of the experimental setup is shown in Figure 6. The gate pulses were generated using PIC18F45K20 microcontroller and fed to the MOSFETs using the gate driver IC IR2110. The gate pulses to the Metal Oxide Semiconductor field effect transistor (MOSFETs) in the inverter are shown in the Figure 7. A small dead time in the gate pulses has also been introduced to avoid the short circuit in the inverter.

As per the designed values, two air core spirally wound inductors were fabricated in the laboratory as shown in Figure 6. It was found that the variation of coupling coefficient with respect to distance between the coils is very less due to the spiral winding. Wireless power transfer is ensured by testing the proposed system upto the secondary terminals of magnetic coupled network, with the conventional dc supply and resistive load. The experimental results are furnished in this section.

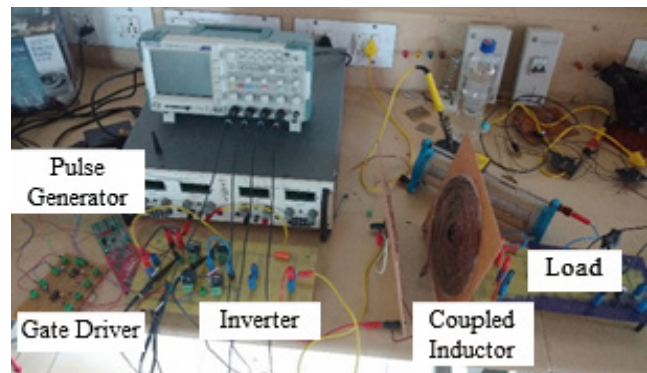

Figure 6. Photograph of the experimental setup.

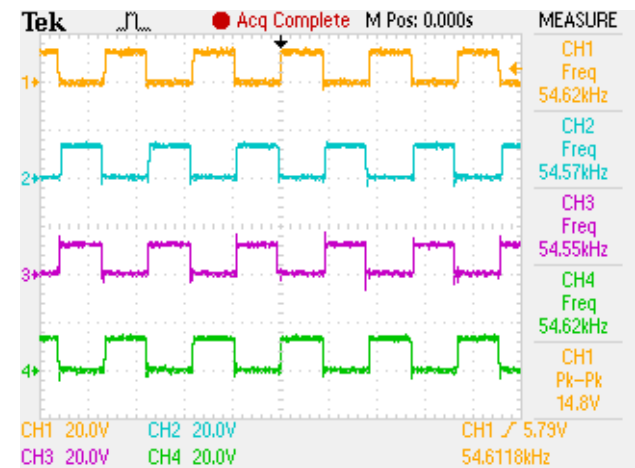

Figure 7. Gate Pulses from IR2110 driver.

The voltage waveform at the primary and secondary terminals of the Magnetic coupled network is shown in Figure 8.

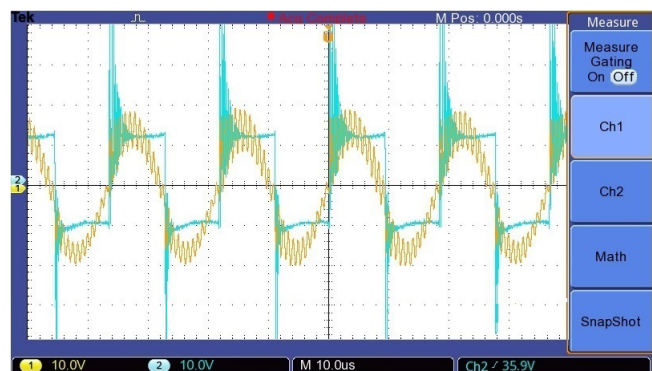

Figure 8. Voltage Waveforms at Primary and Secondary side of Coupled network.

5. Conclusion

In this paper, a system is proposed for charging the battery from PV array in WPT mode. Detailed frequency analysis is carried out for the SS compensation network and the proposed system is simulated using PSIM software. Laboratory prototype is developed and experimental investigation is carried out to validate the simulation results. Both experimental and simulation results correlate with each other resulting in the successful working of the proposed system.

6. Acknowledgement

The authors wish to thank the authorities of VIT University, Chennai for providing the facilities to carry out this work in Smart Grid laboratory, School of Electrical Engineering. Authors also thank Dr. Binu Ben Jose D.R., Associate Professor, VIT University, Chennai for his valuable inputs.

7. References

- Rao TSC, Geetha K. Categories, Standards and Recent Trends in Wireless Power Transfer: A Survey. *Indian Journal of Science and Technology*. 2016 May; 9(20):1-11.
- Tie CH, Gan CK, Ibrahim KA. Probabilistic Impact Assessment of Electric Vehicle Charging on Malaysia Low-Voltage Distribution Networks. *Indian Journal of Science and Technology*. 2015 Feb; 8(3):1-9.
- Elavarasi R, Senthil Kumar PK. An FPGA Based Regenerative Braking System of Electric Vehicle Driven by BLDC Motor. *Indian Journal of Science and Technology*. 2014 Nov; 7(S7):1-5.
- Villa JL, Sallan J, Llombart A, Sanz JF. Design of a high frequency Inductively Coupled Power Transfer System for Electric Vehicle battery charge. *Applied Energy*. 2009; 86(3):355-63.
- Li S, Mi CC. Wireless Power Transfer for Electric Vehicle Applications. *IEEE Journal of Emerging and Selected Topics In Power Electronics*. 2015; 3(1):4-17.
- Cho SY, Lee O, Moon SC, Kim BC, Kim KY. Series-Series Compensated Wireless Power Transfer at Two Different Resonant Frequencies. Melbourne: Proceedings of IEEE conference on ECCE Asia Downunder (ECCE Asia). 2013; p. 1052-58.
- Deepti K, Srihari P, Achari M. MPPT based Auto Integrated Dust Control and Efficient Cooling Mechanism for Improving the Efficiency of Photovoltaic based System. *Indian Journal of Science and Technology*. 2016 Aug; 9(31):1-7.
- Vijayalakshmi M, Ramaprabha R, Ezhilarasan G. Design of Auxiliary Resonant Boost Converter for Flywheel based Photovoltaic Fed Microgrid. *Indian Journal of Science and Technology*. 2016 Apr; 9(13):1-6.
- Prakash G, Subramani C. Modulation and Analysis of Quasi Z-Source Inverter for Solar Photovoltaic System. *Indian Journal of Science and Technology*. 2016 May; 9(19):1-7.
- Karalis A, Joannopoulos JD, Soljacic M. Efficient wireless non-radiative mid-range energy transfer. *Annals of Physics*. 2008; 323(1):34-48.
- Kurs A, Karalis A, Moffatt R, Joannopoulos ID, Fisher P, Soljacic M. Wireless power transfer via strongly coupled magnetic resonances. *Science*. 2007; 317(5834):83-6.
- Muhammad H, Rashid R. Elsevier Inc.: *Power Electronics Handbook*. 3rd ed. 2011.
- Kurs A, Moffatt R, Soljacic M. Simultaneous mid-range power transfer to multiple devices. *Applied Physics Letter*. 2010; 96(4):044102.
- Hamam RE, Karalis A, Joannopoulos JD, Soljacic M. Efficient weakly-radiative wireless energy transfer: An EIT-like approach. *Annals of Physics*. 2009; 324(8):1783-95.
- Yin N, Xu G, Yang Q, Zhao J, Yang X, Jin J, Fu W, Sun M. Analysis of Wireless Energy Transmission for Implantable Device Based on Coupled Magnetic Resonance. *IEEE Transaction on Magnetics*. 2012; 48(2):723-6.
- Hackworth S, Liu X, Li C, Sun M. Wireless solar energy to homes: A magnetic resonance approach. *International Journal of Innovations in Energy Systems and Power*. 2010; 5(1):40-4.
- Khaligh A, Dusmez S. Comprehensive topological analysis of conductive and inductive charging solutions for plug-in electric vehicles. *IEEE Trans. Veh. Technol*. 2012; 61(8):3475-89.
- Zhang F, Liu J, Mao Z, Sun M. Mid-Range Wireless Power Transfer and Its Application to Body Sensor Networks. *Open Journal of Applied Sciences*. 2012; 2(1):35-46.
- Hu AP, Boys JT, Covic GA. ZVS frequency analysis of a current-fed resonant converter. *Acapulco: Proc. of 7th IEEE Int. Power Electron. Congr.* 2000; p. 217-21.
- Moradewicz A, Kazmierkowski M. Contactless Energy Transfer System With FPGA-Controlled Resonant Converter. *IEEE Trans. Industrial Electronics*. 2010; 57(9):3181-90.
- Chen G, Wong S, Tse C, Ruan X. Analysis, Design, and Control of a Transcutaneous Power Regulator for Artificial Hearts. *IEEE Trans. Biomed Circuits Syst*. 2009; 3(1):23-31.