

## Hardware Simulation of Active Lane Keeping Assist Based on Fuzzy Logic

Noor Cholis Basjaruddin<sup>\*1</sup>, Kuspriyanto<sup>2</sup>, Didin Saefudin<sup>3</sup>, Alditama Rachman<sup>4</sup>

<sup>1,3,4</sup>Department of Electrical Engineering Politeknik Negeri Bandung, Jl. Gegerkalong Hilir, Ds. Ciwaruga, Bandung, Indonesia

<sup>2</sup>School of Electrical Engineering and Informatics Bandung Institute of Technology  
Jl. Ganesha 10 Bandung, Indonesia

\*Corresponding author, e-mail: cs\_ppm@yahoo.com

### Abstract

Accidents due to cross the lane (lane departure crash) of achieving 19% of all accidents. These accidents mostly caused because the driver is not concentrating or dozing. A device that can help the driver so that the vehicle does not exit lanes known as Active Lane Keeping Assist (ALKA). ALKA is a subsystem of Advanced Driver Assistance System (ADAS) and is now used in several brands of cars namely Audi, BMW, and Ford. ALKA useful to help the driver, especially on roads with monotonous situations such as toll roads. This paper presents the development of fuzzy logic-based algorithm for ALKA. A battery toy car is used as a hardware simulation to test the algorithm in real time situation. The test results at three different speeds are slow, medium, and high indicate that the algorithm can work according to design.

**Keywords:** lane keeping assist system, fuzzy logic, advanced driver assistance system

**Copyright © 2017 Institute of Advanced Engineering and Science. All rights reserved.**

### 1. Introduction

Accidents due to cross the lane (lane departure crash) of achieving 19% of all accidents [1]. These accidents mostly caused because the driver is not concentrating or dozing [2]. These types of accidents can be reduced by developing a device that can give a warning when going off lane. This device is called Lane Departure Warning (LDW) as developed in [3] and [4]. Some of the vehicles have been equipped with LDW devices include BMW 5 series and 6 series, Volvo S80, and Cadillac STS. Warning on the BMW 5 series and 6 series are given through vibration in the steering wheel, while the Volvo S80 uses a camera to track road markings and alarm to alert.

Devices that have the same functions but has the ability to direct the vehicle back to lane known as Active Lane Keeping Assist (ALKA). Variously called Lane Assist by Audi and Volkswagen, Active Lane Keeping Assist by Mercedes, Lane Departure Warning by BMW or Lane Keeping System by Ford. This device was developed, among others, on the [5] and [6]. ALKA has been used in new-generation vehicles such as the Ford Fusion, Mazda6, and the Skoda Octavia III. ALKA is a subsystem of an ADAS and other subsystems include Overtaking Assistant System [7], Adaptive Cruise Control [8], and Automatic Braking System [9].

Level of automation in Lane Keeping Assist is shown in Figure 1. At LKA level 1 the driver will be assisted by a warning (alarm or haptic) to drive the car to remain on track. The device is known as Lane Departure Warning (LDW). At level 2, LKA will actively adjust the steering wheel if the car cross the lane and this device is known as Active Lane Keeping Assist (ALKA). In ALKA, the driver remained on guard to anticipate unexpected events. If ALKA controlling so that the car is not out of the lane then Active Lane Center Assist (ALCA) serves to control the car in order to stay in the middle lane position. ALCA further ensure the safety car due to the oncoming lane in the middle position. In ALCA driver can be more relaxed because the car is always positioned the middle lane. Cooperation between driver and ALCA developed into a co-operative system. In this system, the driver will be more comfortable because it must hold the steering becomes even less. In driverless cars will be speeding car on the track without the role of the driver.

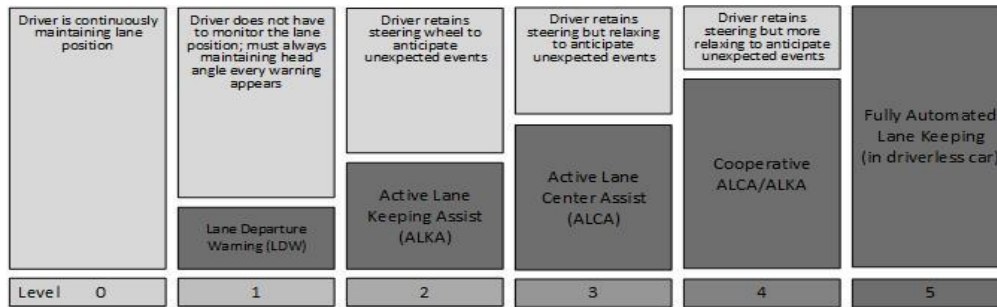

Figure 1. Level of automation LKA

## 2. Research Method

The main issues in the development of ALKA is how to determine if the vehicle cross the lane and how the vehicle can be returned to lane. The first issue can be solved by using a sensor such as camera or infrared sensors that can detect road lane mark. While the second problem can be solved by developing the on-off control or fuzzy logic algorithm.

### 2.1. How ALKA work

ALKA help the driver steer the vehicle to keep driving on the lane chosen. The illustration about how the ALKA works can be seen in Figure 2 [10].

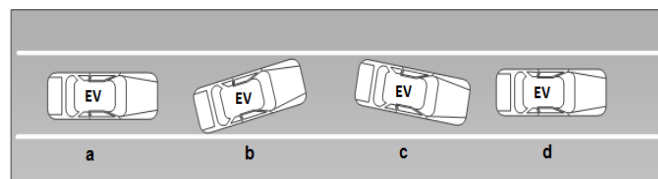

Figure 2. How LKAS work

EV (ego vehicle) that cruised on the multiple lanes road be kept cruised on the lane which be chosen. In certain situation inattentive driver causing the vehicle out of the lane (Figure 2(b)). ALKA will restore automatically toward EV vehicle if the vehicle will exit lane (Figure 2(c)). EV will be positioned between two road lanes by ALKA as in Figure 2(d).

### 2.2. ALKA Based on Fuzzy Logic

The membership functions of the input consist of the speed and deviation [11]. Fuzzy sets of the speed are low speed (LS), medium speed (MS), and high speed (HS). The membership function of the deviation divided into 7 fuzzy sets are small left (SL), medium left (ML), big left (BL), normal (N), small right (SR), medium right (MR), and big right (BR). Input membership functions of the LKAS can be seen in Figure 3 and Figure 4.

Variable of output is steering angle and the membership function can be seen in Figure 5. The fuzzy sets of output are small steering angle (SSA), medium steering angle (MSA), and big steering angle (BSA). In the simulation with toy cars, the range of steering angles is 0-30 degrees. The relationship between input and output is shown in Figure 6 and the basis of rules are shown in Table 1.

Table 1 shows that when the high speed (HS) and big right (BR) in deviation so steering angle is big steering angle (BSA), whereas when low speed (LS) and small left (SL) deviation so steering angle is small steering angle (SSA). In Figure 7 can be seen the display of rule viewer that can be used to evaluate the rule is designed.

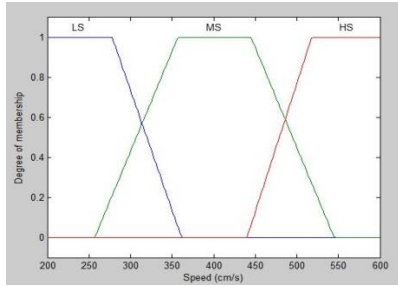

Figure 3. Membership function of speed

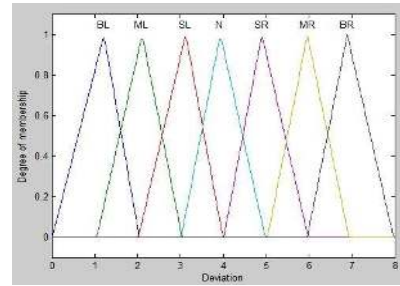

Figure 4. Membership function of deviation

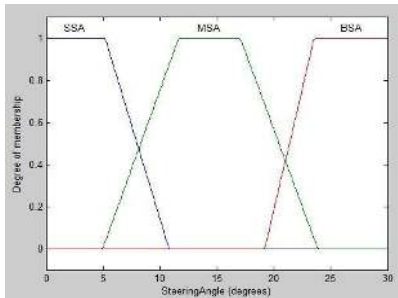

Figure 5. Membership function of output

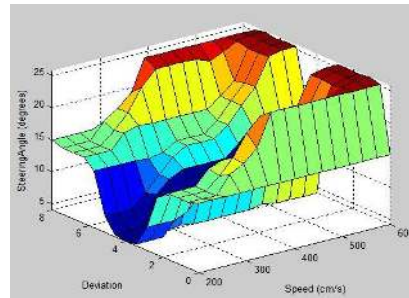

Figure 6. The relationship of input and output

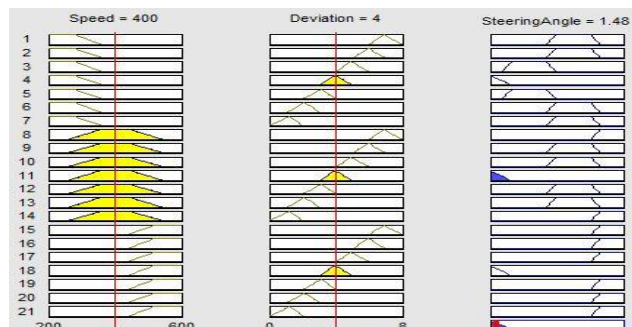

Figure 7. View of the Rule Viewer

Table 1. Rules Base

		Speed		
		HS	MS	LS
Deviation	&	BR	BSA	MSA
	&	MR	BSA	MSA
	&	SR	BSA	SSA
	&	N	ZSA	ZSA
	&	SL	BSA	MSA
	&	ML	BSA	MSA
	&	BL	BSA	MSA

**2.3. Hardware Simulation**

The block diagram of the ALKA hardware simulation is shown in Figure 8. This system using six line tracking sensors TCRT5000L namely Left Sensor 1 (S1), Left Sensor 2 (S2), Left Sensor 3 (S3), Right Sensor 1 (S4), Right Sensor 2 (S5), and Right Sensor 3 (S6). If the toy car veered too far to the left of the lane, the S1, S2, or S3 to logic 1. In this situation deviation is defined worth 1. On the condition of the car to run in the lane of all the sensors will have

logic 0, then the deviation is defined worth 3. If the toy car too turns to the right then the deviation value is 5.

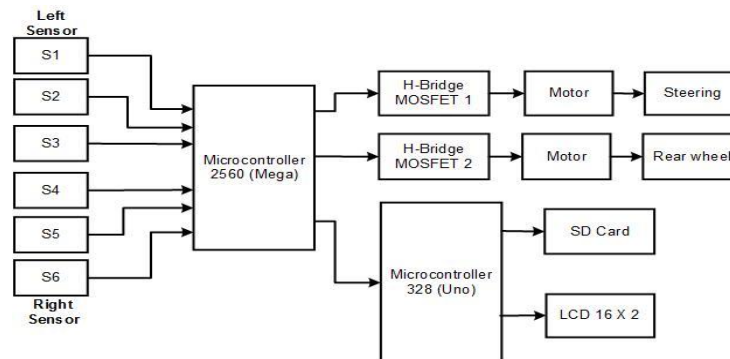

Figure 8. Block diagram of ALKA hardware simulation

Sensors S1-S6 is infrared sensors that serve to read the lane markers and send signals to the microcontroller 2560. Microcontroller 2560 (Arduino Mega) serves to process signals from the sensors to regulate the system, giving instructions to the H-bridge and send the data that has been processed to the microcontroller 328 (Arduino Uno). Microcontroller 328 process data received from the microcontroller 2560 and transmit the data that has been processed to the LCD and SD-Card. LCD function display the data sent from microcontroller 328 previously treated microcontroller 2560. SD Card function storing data sent from microcontroller 328 previously treated microcontroller 2560. H-Bridge serves control the speed and rotary direction of motors according to instructions from the microcontroller 2560.

Based on a system block diagram in Figure 8, sensors send signals of reading lane marker to the microcontroller. The working of the system is when the left sensor S1 active causing motor steering wheel turn slightly towards the right and the car speed will be slower, then if the left sensor S2 actively causing motor steering wheel turn was to the right and the car speed will be slower than when the sensor S1 active then when the left sensor S3 actively causing motor steering wheel turn sharply to the right and the car speed will be slower than when the sensor S2 is active. Furthermore, if the sensor right-S6 actively causing motor steering wheel turn slightly to the left and the car speed will be slower, then the sensor right-S5 actively causing motor steering wheel turn was to the left and the car speed will be slower than when the sensor S6 is active, then when right sensor active S4 causing motor steering wheel turn sharply to the left and the car speed will be slower than when the sensor S2 is active.

The entire output data that has been processed in the controller 2560 will be sent to the controller 328 which will then be displayed on the LCD, and then the data will be stored on storage devices SD Card. The car are designed to have 3 levels of speed namely slow, medium, and high so it can be used for testing whole speed which has been defined by the membership function of speed. The ALKA hardware simulation is built using a toy car, as shown in Figure 9 and Figure 10 [12].



Figure 9. Front view of experiment car



Figure 10. Experiment car in lane

### 3. Results and Analysis

Fuzzy-logic based ALKA algorithm is tested in slow, medium, and high speed situations. The test results can be seen in

Figure 11,

Figure 12, and

Figure 13.

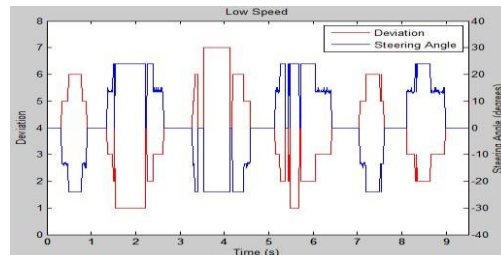

Figure 11. Test results on slow speed

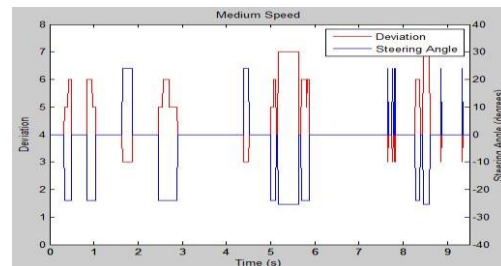

Figure 12. Test results on medium speed

The test results indicate that the toy car tends to turn to the right, causing deviations 5 and 6 are common. This situation is caused by mechanical influences of the toy car. In the real situation, the vehicle can turn due to the driver's negligence in controlling the steering. In the real situation, the vehicle is likely to turn to the right or left if the steering is uncontrolled. The test results also show that the developed algorithm can restore the direction of the toy car to the lane and prevent the toy car from going out of the lane.

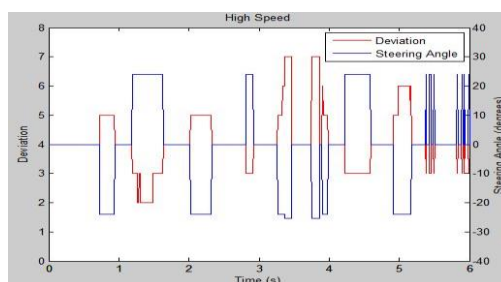

Figure 13. Test results on High speed

At low speed testing (see

Figure 11) car deviate more frequently than when the car drove at medium and high speeds. At medium speed testing (see

Figure 12) can be seen that the car is running with do not deviate too much than at low speeds. Similarly, in high-speed testing (see

Figure 13) car remains stable compared with the low speed.

Test to get the safety index is done by running the car at low speed, medium speed, and high speed respectively 10 times. The system is considered successful if it can run on the track until testing is completed. If the car off the track before the test is completed, the system is considered a failure and reduce the safety index. The safety index is ratio between the number of successful trials with the many experiments conducted. In this research the safety index at different speeds are 83.3% (low speed), 100% (medium speed), and 50% (high speed).

#### 4. Conclusion

The test results prove that the ALKA fuzzy logic algorithm is developed to work as designed. The highest safety index occurred at a medium speed, while the lowest occurred in high-speed testing. On the implementation in a real vehicle needed to improve the algorithm so that the driver or passenger comfort can be maintained. The improvements include adding a fuzzy set on the input and output as well as using the camera as a sensor.

#### References

- [1] M Benavente, HA Rothenberg, MAK Jr. *Evaluation of Frequency and Injury Outcomes of Lane Departure Crashes*. 2006 ITE Annual Meeting and Exhibit Compendium of Technical Papers. Milwaukee WI. 2006.
- [2] JB Cicchino, DS Zuby. *Prevalence of Driver Physical Factors Leading to Unintentional Lane Departure Crashes*. Insurance Institute for Highway Safety. 2016.
- [3] T Aung, MH Zaw. *Video Based Lane Departure Warning System using Hough Transform*. International Conference on Advances in Engineering and Technology (ICAET'2014). Singapore. 2014.
- [4] J HE. *Lane Departure Warning System for Vehicle Active Safety Perception Platform*. 2nd International Conference on Electronic & Mechanical Engineering and Information Technology (EMEIT-2012). China. 2012.
- [5] JF Liu, JH Wu, YF Su. *Development of an Interactive Lane Keeping Control System for Vehicle*. Vehicle Power and Propulsion Conference. Arlington, TX. 2007.
- [6] NM Enache, S Guegan, F Desnoyer, H Vorobieva. *Lane Keeping and Lane Departure Avoidance by Rear Wheels Steering*. Intelligent Vehicles Symposium. Alcalá de Henares, Spain. 2012.
- [7] NC Basjaruddin, Kuspriyanto, D Saefudin, E Rakhman, M Ramadlan. Overtaking Assistant System based on Fuzzy Logic. *Telkomnika (Telecommunication Computing Electronics and Control)*. 2015; 13(1).
- [8] NC Basjaruddin, Kuspriyanto, D Saefudin, IK Nugraha. Developing Adaptive Cruise Control Based on Fuzzy Logic Using Hardware Simulation. *International Journal of Electrical and Computer Engineering (IJECE)*. 2014; 4(6).
- [9] NC Basjaruddin, Kuspriyanto, Suhendar, D Saefudin, VA Azis. Hardware Simulation of Automatic Braking System Based On Fuzzy Logic Control. *Journal of Mechatronics. Electrical Power. and Vehicular Technology*. 2016; 7(1): 1-6.
- [10] NC Basjaruddin, Kuspriyanto, Suhendar, D Saefudin, SA Aryani. *Lane Keeping Assist System Based on Fuzzy Logic*. International Electronics Symposium (IES). Surabaya. 2015.
- [11] SA Aryani. Simulation of Lane Keeping Assist System Based on Fuzzy Logic using Remote Control Car. *Electrical Engineering Departement. Bandung State Polytechnic*. Bandung. 2014.
- [12] AE Rachman. Lane Keeping Assist on Battery Toy Car Based on Fuzzy Logic. *Electrical Engineering Departement. Bandung State Polytechnic*. Bandung. 2015.