

A Fuzzy Logic Control Strategy for Doubly Fed Induction Generator for Improved Performance under Faulty Operating Conditions

G. Venu Madhav*, Y. P. Obulesu**

* Department of Electrical and Electronics Engineering, Padmasri Dr. B. V. Raju Institute of Technology

** Department of Electrical and Electronics Engineering, LakiReddy BaliReddy College of Engineering

Article Info

Article history:

Received Mar 12, 2014

Revised May 21, 2014

Accepted Jun 20, 2014

Keyword:

Wind turbine

Doubly fed induction generator

Fuzzy logic control

PI controller

Synchronous generator

ABSTRACT

In this paper, decouple PI control for output active and reactive powers which is the common control technique for power converter of Doubly Fed Induction Generator (DFIG) is presented. But there are some disadvantages with this control method like uncertainty about the exact model, behavior of some parameters or unpredictable wind speed and tuning of PI parameters. To overcome the mentioned disadvantages a fuzzy logic control of DFIG wind turbine is presented and is compared with PI controller. To validate the proposed scheme, simulation results are presented, these results showed that the performance of fuzzy control of DFIG is excellent and it improves power quality and stability of wind turbine compared to PI controller. The Fuzzy logic controller is applied to rotor side converter for active power control and voltage regulation of wind turbine. The entire work is carried out in MATLAB/Simulink. Different faulty operating conditions are considered to prove the effective implementation of the proposed control scheme.

Copyright © 2014 Institute of Advanced Engineering and Science.
All rights reserved.

Corresponding Author:

G. Venu Madhav,

Department of Electrical and Electronics Engineering,

Padmasri Dr. B. V. Raju Institute of Technology,

Vishnupur, Narsapur, Medak Dist., 502313, AP, India.

Email: venumadhav.gopala@gmail.com

1. INTRODUCTION

Wind energy is one of the extra ordinary sources of renewable energy due to its clean character and free availability. Moreover, because of reducing the cost and improving techniques, the growth of wind energy in Distributed Generation (DG) units has developed rapidly.

In terms of wind power generation technology, because of numerous technical benefits (higher energy yield, reducing power fluctuations and improving var supply) the modern MW-size wind turbines always use variable speed operation which is achieved by a converter system [1]. These converters are typically associated with individual generators and they contribute significantly to the costs of wind turbines. Between variable speed wind turbine generators, Doubly Fed Induction Generators (DFIGs) and Permanent Magnet Synchronous Generators (PMSGs) with primary converters are emerging as the preferred technologies [2].

Doubly Fed Induction Generator (DFIG) is one of the most popular wind turbines which include an induction generator with slip ring, a partial scale power electronic converter and a common DC-link capacitor. Power electronic converter which encompasses a back to back AC-DC-AC voltage source converter has two main parts; Grid Side Converter (GSC) that rectifies grid voltage and Rotor Side Converter (RSC) which feeds rotor circuit. Power converter only processes slip power therefore it's designed in partial scale and just about 30% of generator rated power [3] which makes it attractive from economical point of view.

Many different structure and control algorithm can be used for control of power converter. In this paper, decouple PI control of output active and reactive power to improve dynamic behavior of wind turbine which is one of the most common control techniques is presented. But due to uncertainty about the exact model and behavior of some parameters such as wind, wind turbine, etc and also parameters values differences during operation because of temperature, events or unpredictable wind speed, tuning of PI parameters is one of the main problems in this control method. Based on the analysis, fuzzy logic controller has been designed to improve the dynamic performance of DFIG.

In fuzzy logic control there is no need of a detailed mathematical model of the system and just using the knowledge of the total operation and behavior of system is enough in designing the controller. The performance of PI control is compared with that of fuzzy logic controller and it is investigated that the dynamic performance of fuzzy logic controller is quite good in comparison with PI controller.

In this paper, the dynamic performance of DFIG under different fault conditions is investigated.

2. THE SAMPLE TEST SYSTEM

Sample test system is shown in Figure 1. It consists of three main feeders, two DG units and five local loads. The two DG units are a DFIG and a synchronous generator. In the proposed system, different cases of abnormal conditions are considered, when there is a single phase line to ground fault near DFIG, a single phase line to ground fault on the grid and three phase line to ground fault near DFIG etc. The configurations and parameters of the DFIG and synchronous generator system are extracted from [4]. Main grid is represented by a three phase 69 kV voltage source with 1000MVA short circuit capacity and X/R ratio of 22.2.

Connection point of main and micro-grid systems is called Point of Common Coupling (PCC). 2MVA DFIG wind turbine consists of power electronic converter control unit which feeds generator's rotor and grid. Power electronic converter unit is to control active and reactive power of generator separately and to improve power quality and stability of the network. The parameters of 5MVA synchronous generator are given in Table 1.

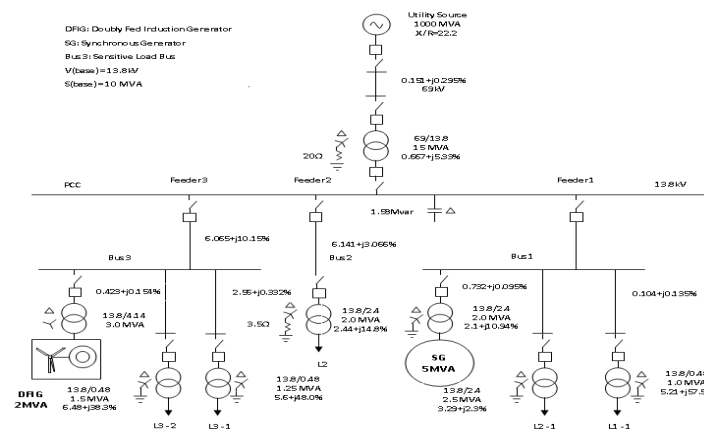

Figure 1. Sample test system

3. MODELING OF BASIC COMPONENTS

3.1. Wind and Wind Turbine

Wind effect plays a fundamental rule in wind turbine modeling especially for interaction analysis between wind turbines and the power system to which they are connected. Wind model describes wind fluctuation in wind speed which causes power fluctuation in generator. For wind model four components can be considered, as describe in (1) [5]:

$$V_{wind} = V_{bw} + V_{gw} + V_{rw} + V_{nw} \tag{1}$$

Where, V_{bw} = Base wind component (m/s); V_{gw} = Gust wind component (m/s); V_{rw} = Ramp wind component (m/s); V_{nw} = Noise wind component (m/s).

The base component is a constant speed; wind gust component may be expressed as a sine or cosine wave function or their combination [6]; a simple ramp function will be used for ramp component and a triangle wave for noise function which its frequency and amplitude will be accordingly adjusted. The simple block diagram for generation of wind speed is illustrated in Figure 2 and which includes all of four components mentioned above.

For electrical analysis, a simplified aerodynamic model of wind turbine is normally used. Accordingly wind blade torque from wind speed will be produced which is as follows:

$$\lambda = \frac{R\omega_{rot}}{V_{wind}} \quad (2)$$

$$P_w = \frac{1}{2} \rho \pi R^2 C_p (\lambda, \theta) V_{wind}^3 \quad (3)$$

$$T_w = \frac{P_w}{\omega_{rot}} = \frac{\rho \pi R^2 C_p (\lambda, \theta) V_{wind}^3}{2\lambda} \quad (4)$$

Where T_w is an aerodynamic torque extracted from the wind (Nm), ρ is the air density (kg/m^3), R is the wind turbine rotor radius (m), V_{wind} is the equivalent wind speed (m/s), θ is the pitch angle of the rotor (deg), λ is the tip speed ratio, ω_{rot} is the mechanical speed of the generator (rad/s) and C_p is the power coefficient.

C_p can be expressed as a function of the Tip Speed Ratio (TSR) and pitch angle which is given by (5) [7], [8]:

$$C_p (\lambda, \theta) = 0.22 \left(\frac{116}{\lambda_i} - 0.4\theta - 5 \right) e^{-\frac{12.5}{\lambda_i}} \quad (5)$$

$$\lambda_i = \frac{1}{\left(\frac{1}{\lambda + 0.08\theta} - \frac{0.035}{\theta^3 + 1} \right)}$$

By increasing pitch angle, power coefficient and therefore torque decreases moreover C_p growth rate changes in different speed by λ .

3.2. DFIG Model

As illustrated in Figure 3, DFIG system is a wound rotor induction generator with slip ring, with stator directly connected to the grid and with rotor interfaced through a back to back partial scale power converter. The converter consists of two conventional voltage source converters that are called Rotor Side Converter (RSC) and Grid Side Converter (GSC) and a common DC-link [3]. Consequently the DFIG can be regarded as a traditional induction machine with a nonzero rotor voltage.

Using the Concordia and Park transformation allows to write a dynamic model in a d-q reference frame from the traditional a-b-c frame as follows [9]:

Electromagnetic torque:

$$T_{em} = \frac{3}{2} (\Psi_{ds} i_{qs} - \Psi_{qs} i_{ds}) \quad (6)$$

Active and reactive power of stator:

$$P_s = \frac{3}{2} (V_{ds} i_{ds} + V_{qs} i_{qs}) \quad (7)$$

$$Q_s = \frac{3}{2} (V_{ds} i_{qs} - V_{qs} i_{ds}) \quad (8)$$

Table 1. Synchronous generator parameters

Rated Power	5 MVA	Rated Voltage	13.8 kV
R_a	0.0052 p.u	X_{ls}	0.2 p.u
X_d	2.86 p.u	X_q	2.0 p.u
X_d'	0.7 p.u	X_q'	0.85 p.u
X_d''	0.22 p.u	X_q''	0.2 p.u
T_{do}	3.4 s	T_{qo}	0.05 s
T_{d0}'	0.01 s	H	2.9 s

Table 2. Induction generator parameters of wind turbine (DFIG)

Rated Power	2 MVA
Rated Voltage	0.69 kV
Stator/rotor ratio	0.4333
Angular moment of inertia (J=2H)	1.8293 p.u
Mechanical damping	0.02 p.u
Stator resistance	0.0183 p.u
Rotor resistance	0.0205 p.u
Stator leakage inductance	0.2621 p.u
Rotor leakage inductance	0.3152 p.u
Mutual inductance	5.572 p.u

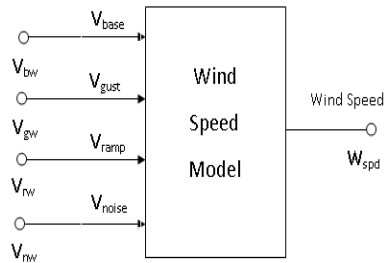

Figure 2. Model of wind speed

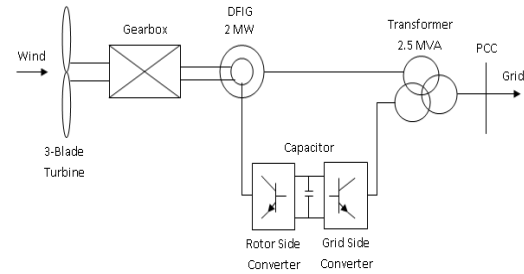

Figure 3. Schematic representation of a DFIG wind turbine

Table 2 shows the parameters of the DFIG which is used in this proposed system. The rotor side converter operates at the slip frequency. The power converter processes only the slip power, thus if the DFIG to be varied within about $\pm 30\%$ slip, the rating of power converter is only about 30% of rated power of the wind turbine [10].

Setting the stator flux vector to align with d -axis and assuming the per phase stator resistance negligible, we have:

$$\Psi_s = \Psi_{ds}, V_s = V_{qs} \quad (9)$$

$$|\Psi_s| \angle \theta_s = \int (V_s - r_s i_s) dt \quad (10)$$

Substitution (9) in (7) and (8), the active and reactive power of stator flow into the grid can be expressed as:

$$P_s = -\frac{3}{2} \frac{L_m}{L_m + L_s} V_s i_{qr} \quad (11)$$

$$Q_s = \frac{3}{2} \frac{V_s}{L_m + L_s} \left(L_m i_{dr} - \frac{V_s}{\omega_s} \right) \quad (12)$$

Where, i_{qr} and i_{dr} are rotor current (A) in d- and q-axis respectively, L_{ls} and L_m are stator leakage and mutual inductance (H), ω_s is the electrical angular velocity (rad/s) and V_s is the magnitude of the stator phase voltage (V). This means that using vector control with d-axis oriented stator flux vector in rotor side converter, active and reactive power can be controlled separately. This will be achieved by regulating i_{qr} and i_{dr} respectively.

Grid side converter is presented for keeping DC link voltage of capacitor constant regardless to the magnitude and direction of rotor power. Neglecting power losses in the converter, capacitor current can be described as follow:

$$i_{dc} = C \frac{dV_{dc}}{dt} = \frac{3}{4} m i_{gcd} - i_{dcr} \tag{13}$$

Where i_{gcd} stands for the d-axis current flowing between grid and grid side converter (A), i_{dcr} is the rotor side DC current (A), C is the DC-link capacitance (F) and m is the PWM modulation index of the grid side converter.

The reactive power flow into the grid from GSC can be expressed as:

$$Q_g = \frac{3}{2} V_g i_{gcq} \tag{14}$$

Where V_g is the magnitude of grid phase voltage (V) and i_{gcq} is q-axis current of grid side converter (A). Therefore it is seen from (13) and (14), by adjusting i_{gcd} and i_{gcq} , DC-link voltage and Q_g can be controlled respectively.

3.3. Pitch Control

To produce a maximum energy, the blade angle must be tuned with wind straightforward using pitch angle control of wind turbine blades. It is worth noticing that we can use this characteristic in abnormal conditions such as grid faults to protect generator from over speeding. In two different cases, an increasing rotor speed may be occurred; a wind speed as input power and an abnormal case due to a fault existence.

These must be distinguished first, before a control takes place. When the output terminal voltage falls under 0.9 p.u and the rotor speed is increased, it means a fault is happened.

To actuate the event and to decrease the rotor speed, the pitch angle must be manipulated. An emergency pitch angle should be added with rate of +10(deg/s/1000rpm) for over speed protection.

4. A FUZZY LOGIC AND PI CONTROL STRATEGY

The four main components of fuzzy logic controller are fuzzification, fuzzy inference engine, rule base and defuzzification. Inputs are fuzzified, then based on rule base and inference system, outputs are produced and finally the fuzzy outputs are defuzzified and applied to the main control system. Error of inputs from their references and error deviations in any time interval are chosen as inputs. Mamdani type fuzzy logic control is considered here.

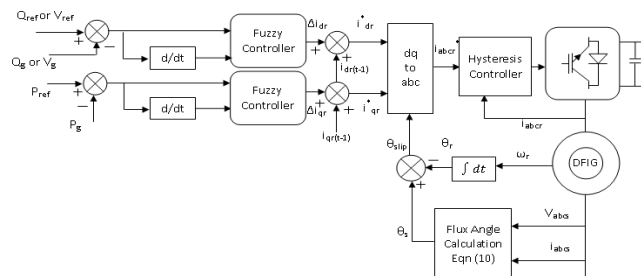

Figure 4. Rotor side converter fuzzy controller unit structure

Figure 4 shows the block diagram of rotor side converter with fuzzy controllers. Similarly, PI controllers are used in place of fuzzy controllers. The main objectives of this part are active power control and voltage regulation of DFIG wind turbine using output reactive power control. As illustrated in Figure 6

rotor side converter manages to follow reference active (P_{ref}) power and voltage (V_{ref}) separately using fuzzy controllers, hysteresis current controller converter and vector control algorithm. Based on (11), (12) and Figure 6, inputs of fuzzy controller are error in active and reactive power or voltage and the rate of changes in errors in any time interval. After the production of reference d- and q-axis rotor currents, they converted to a-b-c reference frame using flux angle, rotor angle and finally slip angle calculation and Concordia and Park transformation matrix. Then they applied to a hysteresis current controller to be compared with actual currents and produce switching time intervals of converter.

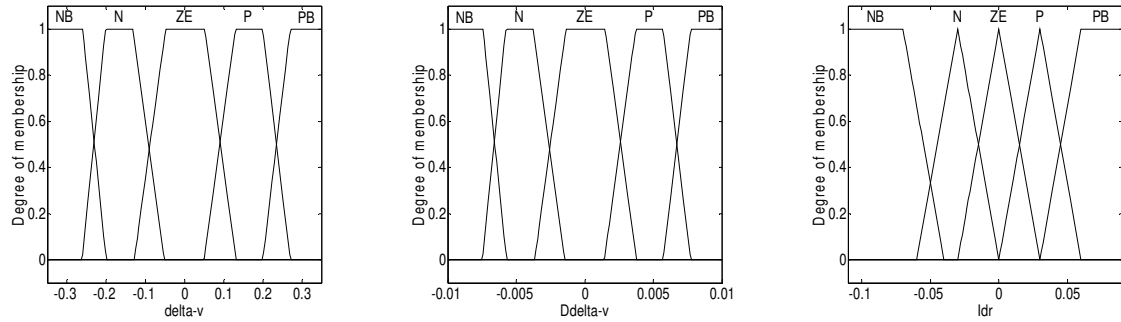

Figure 5. Input and output membership functions of voltage controller

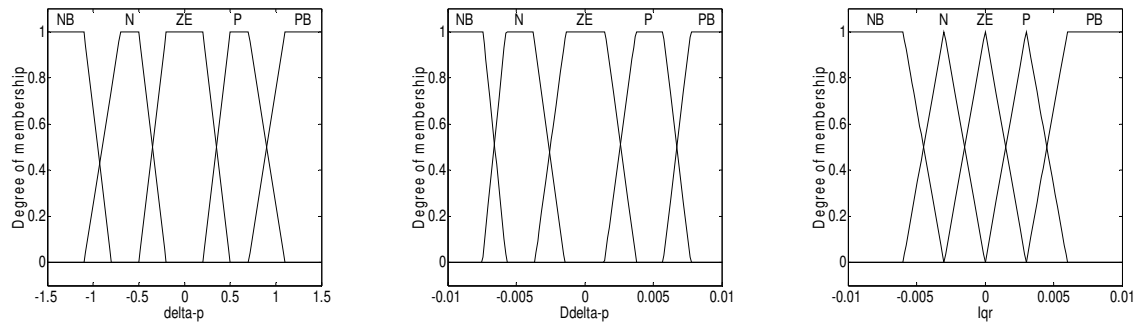

Figure 6. Input and output membership functions of active power controller

Table 3. Rule bases of voltage fuzzy controller

		$\Delta E (V)$				
		NB	N	ZE	P	PB
ΔI_{dr}	E (V)	NB	NB	N	N	ZE
	N	NB	N	N	ZE	P
	ZE	N	N	ZE	P	P
	P	N	ZE	P	P	PB
	PB	ZE	P	P	PB	PB

Table 4. Rule bases of active power fuzzy controller

		$\Delta E (P)$				
		NB	N	ZE	P	PB
ΔI_{qr}	E (P)	NB	NB	N	N	ZE
	N	NB	N	N	ZE	P
	ZE	N	N	ZE	P	P
	P	N	ZE	P	P	PB
	PB	ZE	P	P	PB	PB

Figure 5 and 6 shows inputs and output membership functions. To avoid miscalculations due to fluctuations in wind speed and the effects of noise on data, trapezoidal membership functions are chosen to

have smooth and constant region in the main points. Rule bases are shown in Table 3 and 4. NB, N, ZE, P and PB represents negative big, negative, zero, positive and positive big respectively. For instance when E (P), the error of active power and ΔE (P), the rate of change of active power error in a time interval, are NB mean the output voltage is more than reference and is increasing dramatically therefore reference q-axis rotor current which controls active power should decrease rapidly that represents NB.

In this paper, Proportional and Integral (PI) controllers are used in place of fuzzy controllers as shown in Figure 4 and the results of both the controllers are compared. PI controller blocks operate in the feed forward path of both active power (P) and reactive power (Q) feedback loops. PI controller gains are tuned by using the Simulink Control Design software which makes the control systems design and analyze in Simulink environment.

5. RESULTS AND DISCUSSION

For investigation of dynamic behavior of proposed system with fuzzy logic and PI controller, different situations and events are considered. Based on different fault locations and severity, the system has different responses. In each condition, different parameters such as voltage, active and reactive power, rotor currents and dc link voltage are taken to prove the capability of the proposed controller.

(a) Single line to ground fault near synchronous generator:

A single line to ground short circuit fault with duration of 0.1s is occurred near the synchronous generator. The fault duration is from 5s to 5.1s. Figure 7 shows different responses of the synchronous generator and DFIG in test systems. During the fault, there is little variation in active and reactive power of wind turbine and in AC and DC-link voltages because the fault is far from the wind turbine and near the synchronous generator, so, variation in active and reactive power of synchronous generator is high.

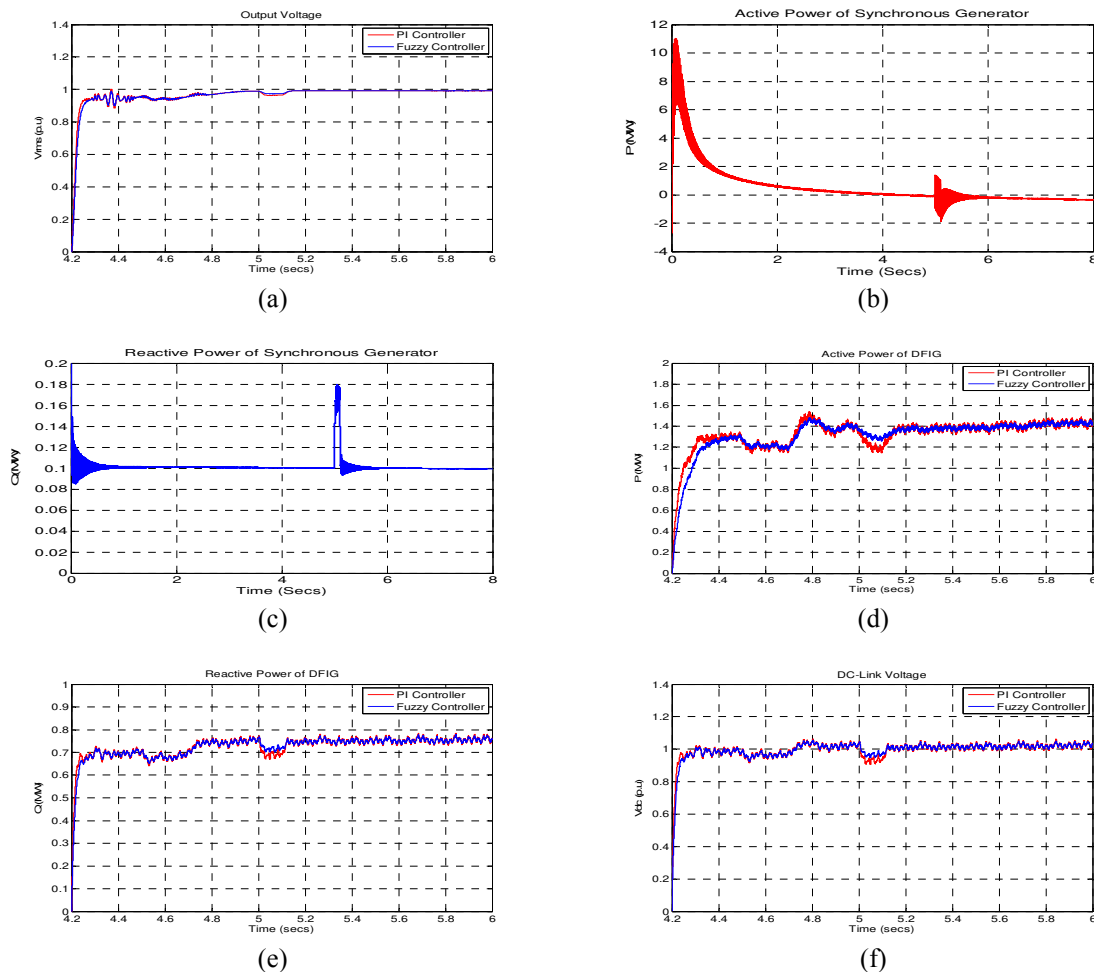

Figure 7. Single line to ground fault near synchronous generator at 5s with duration of 0.1s (a) output voltage (b) active power of synchronous generator (c) reactive power of synchronous generator (d) active power of DFIG (e) reactive power of DFIG (f) dc-link voltage

GSC generally controls the dc bus voltage of the back-to-back converter and the exchange of reactive power to the grid. The proposed controllers produce the necessary values of direct and quadrature axis rotor currents which are converted into three phase currents to maintain control on the machine stability. The power delivered from RSC will be increased due to increase of rotor currents and voltages which in turn increase the dc bus voltage.

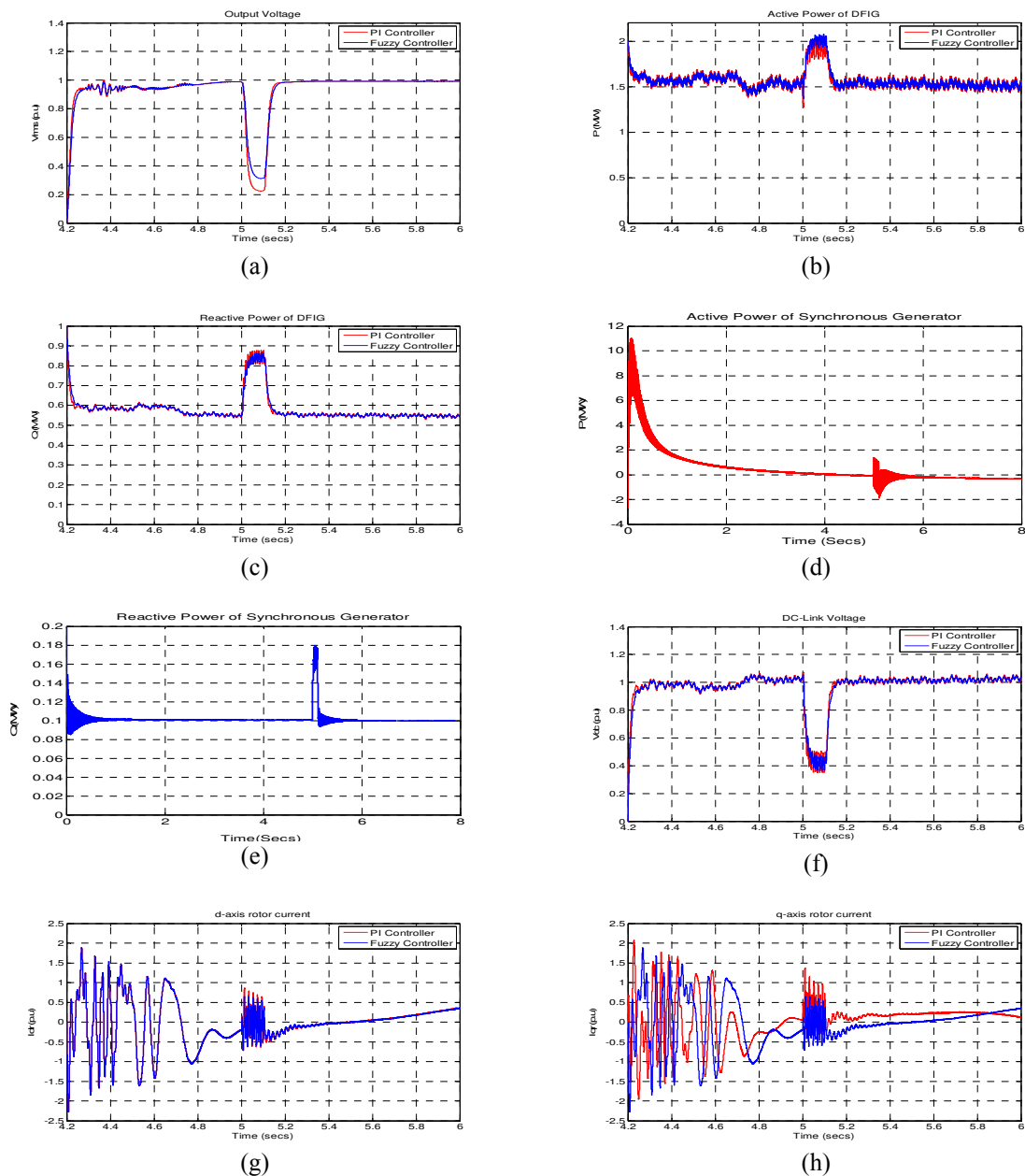

Figure 8. Single line to ground fault near DFIG wind Turbine (a) output voltage (b) active power of DFIG (c) reactive power of DFIG (d) active power of synchronous generator (e) reactive power of synchronous generator (f) dc-link voltage (g) d-axis rotor current (h) q-axis rotor current

(b) Three line to ground fault near DFIG:

To prove performance of fuzzy logic controller in comparison with decouple PI control and to investigate dynamic behavior of doubly fed induction generator in one of the worst case situations, a severe three line to ground short circuit fault is considered near the wind turbine. Figure 9 shows the waveforms, there is reduction in voltage and it reduces to near zero. In addition, active and reactive deviations in DFIG are the most severe. Rotor current reaches to its limit and crowbar protection unit short circuits the rotor and

rotor side converter but still stator is connected to the network and due to super synchronous operation of wind turbine it can produce active power. The proposed controller maintains the rotor currents under their safety limits without high over currents. Due to mitigation of the over currents of the rotor the back-to-back converter is less affected by this perturbation which produces short dc bus voltage oscillations.

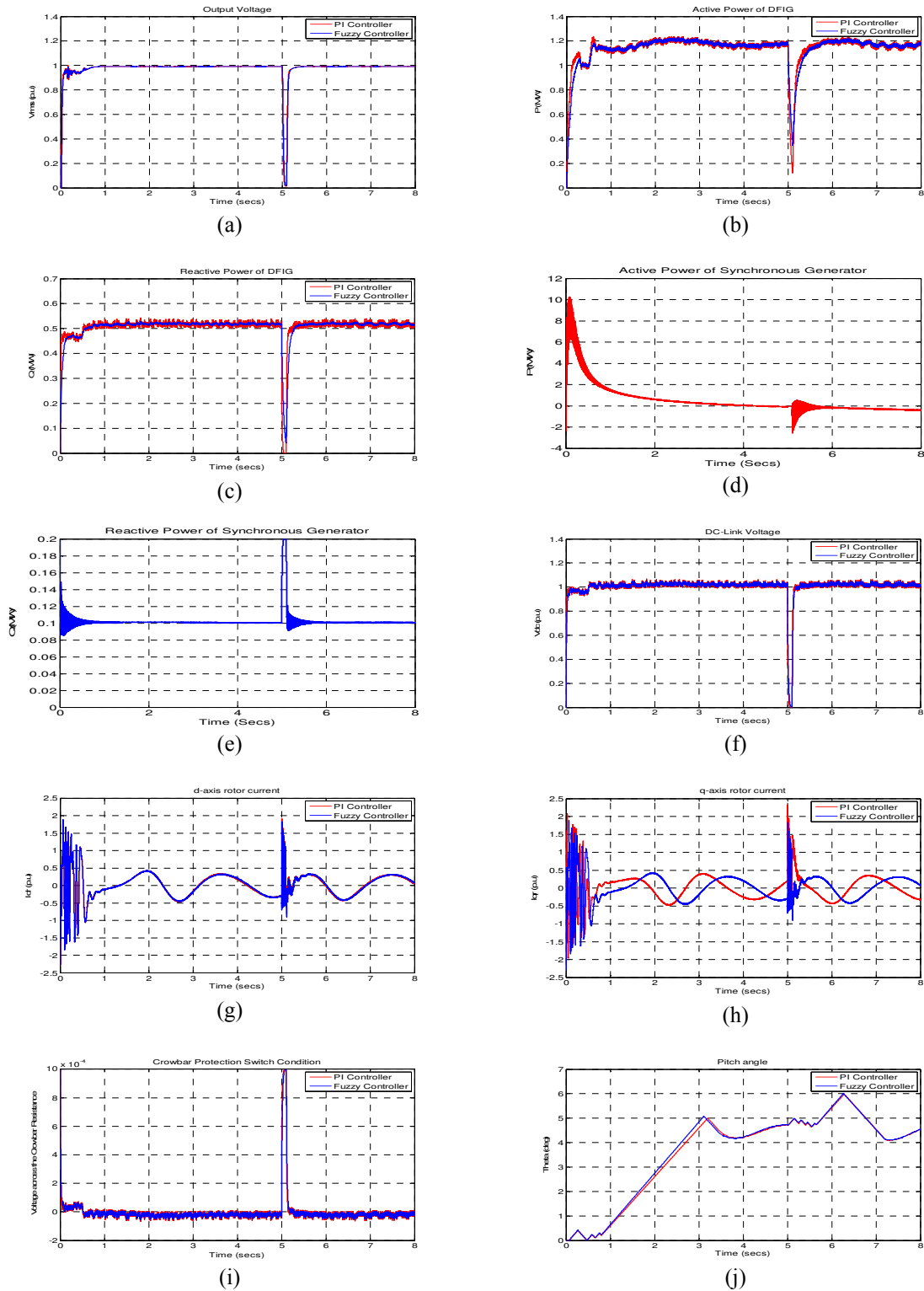

Figure 9. Three line to ground short circuit fault near DFIG wind turbine (a) output voltage (b) active power of DFIG (c) reactive power of DFIG (d) active power of synchronous generator (e) reactive power of synchronous generator (f) dc-link voltage (g) d-axis rotor current (h) q-axis rotor current (i) voltage across the crowbar resistance (j) pitch angle

Furthermore, beside electrical protection, an emergency pitch angle is introduced with slope of ± 10 (deg/s). When voltage drops under 0.8 p.u and wind speed is constant, emergency pitch angle due to external fault activates to protect DFIG from over speeding and keep output power below rated value. As soon as voltage and speed come back to normal situation it starts to decrease and returns to normal situation. Grid side converter acts as STATCOM and tries to restore voltage. After rotor current returns under the limit and a constant time delay, crowbar switch opens and rotor side converter continues to operate. As illustrated in Figure 9, fuzzy control unit of wind turbine maintains good stability and restores parameters to their predefined values as well in comparison with PI controller.

6. CONCLUSION

In this paper, dynamic performance of DFIG under different fault conditions with PI controller and fuzzy logic control has been investigated. The PI controller and fuzzy logic controller has been designed and implemented in MATLAB/Simulink. To prove the performance of controller unit, the abnormal situations of single line to ground fault near and away from DFIG and three phase line to ground fault near DFIG are exerted on proposed system. The output voltage, active and reactive powers, dc-link voltage, direct and quadrature axis rotor currents are improved for fuzzy logic controller compared to PI controller for different cases of fault near and away from DFIG. The performance of fuzzy logic controller is found quite satisfactory in improving stability and power quality of wind turbine compared to PI controller. Closer fault location to the wind turbine causes more severe effect and a three line to ground short circuit fault near the wind turbine as the worst case in which voltage decreases until zero and rotor current exceeds its limit.

REFERENCES

- [1] Datta R, Ranganathan VT. Variable-Speed Wind Power Generation Using Doubly Fed Wound Rotor Induction Machine - A comparison With Alternative Schemes. *IEEE Transactions on Energy Conversion*. 2002; 17(3): 414–421.
- [2] Li G, M Yin, M Zhou, C Zhao. Decoupling control for multi terminal VSCHVDC based wind farm interconnection. *IEEE. Power Engineering Society General Meeting*. 2007: 1-6.
- [3] Holdsworth L, XG Wu, JB Ekanayake and N Jenkins. Comparison of fixed speed and doubly-fed induction wind turbines during power system disturbances. *IEE Proc. Gener. Transm. Distrib.*, 2003; 150 (3): 343-352.
- [4] Katiraei F, MR Irvani and PW Lehn. Micro-Grid Autonomous Operation During and Subsequent to Islanding Process. *IEEE Trans. Power Delivery*. 2005: 20(1).
- [5] Youjie Ma, Haishan Yang, Xuesong Zhou, Li Ji, 2009. *The dynamic modeling of wind farms considering wake effects and its optimal distribution*. World Non-Grid-Connected Wind Power and Energy Conference, 2009. WNWEC 2009; 22 (2): 1 - 4.
- [6] Reynolds MG. Stability of wind turbine generators to wind gusts. Purdue University Report TR-EE 79-20.
- [7] Heier S. Grid integration of wind energy Conversion systems. Chichester: John Wiley and Sons Ltd. 1998; 35-302.
- [8] Slaotweg G, H Polinder, WL Kling. *Dynamic modeling of a wind turbine with direct drive synchronous generator and back to back voltage source converter and its control*. Proceedings of the European Wind Energy Conference, Copenhagen, Denmark. 2001; 1014-1017.
- [9] Bose BK. 1986. Power electronics and AC drives. New Jersey: Prentice-Hall. 1986; 46-52.
- [10] Jang J, Y Kim, D Lee. Active and reactive power control of DFIG for wind energy conversion under unbalanced grid voltage. Proc. IEEE Power Electronics and Motion Control Conference. 2006; 3.

BIOGRAPHIES OF AUTHORS



G. Venu Madhav received his B.Tech. degree in Electrical and Electronics Engineering from Jawaharlal Nehru Technological University, Hyderabad in 2002. M.Tech. degree in Power and Industrial Drives from Jawaharlal Nehru Technological University, Anantapur in 2005. He is pursuing Ph.D. from Jawaharlal Nehru Technological University, Hyderabad. Currently he is working as a Associate Professor, Dept. of EEE, BVRIT, Narsapur, Medak Dist. He has published several National and International Journals and Conferences. His area of interest is Advanced Control strategies of Electric Drives, Microprocessors and Microcontrollers, Fuzzy logic & ANN applications, and Network Analysis. Have professional society memberships in IETE (M), ISTE (LM), IE (AM), SESI (LM) and IAENG (M).



Dr. Y.P.Obulesu received his B.E. degree in Electrical and Electronics Engineering from Andhra University, Visakhapatnam in 1996. M.Tech. degree in Power Electronics and Drives from IIT, Kharagpur, in 1998. He received his Ph.D. degree from Jawaharlal Nehru Technological University, Hyderabad in 2006. Currently he is working as a Professor and Dean of R & D, Dept. of EEE, LBRCEC, Mylavaram, Krishna Dist. He has published several National and International Journals and Conferences. His area of interest is Advanced Control strategies of Electric Drives, SMPS, Multilevel inverters, Harmonic minimization, power quality, FACTs, Solar powered Electric Vehicles, DSP & FPGA control of power electronics and drives, Wavelets, Fuzzy logic & ANN applications to power electronics and drives. Have professional society memberships in IEEE, ISTE (LM) and SSI (LM).