

Design and Analysis of RBFN Based Single MPPT Controller for Hybrid Solar and Wind Energy System

Kumar. K¹, Ramesh Babu. N^{2*}, Prabhu. K.R³

Abstract—In this paper, RBFN based single MPPT control algorithm for hybrid solar and wind energy system is designed and analyzed for standalone and grid connected applications. The extraction of maximum power from the intermittent and erratic nature renewable energy sources are the main target in the hybrid renewable energy system. In the literature, many researchers developed an individual MPPT control algorithm for solar and wind energy system, which intern increases the number of control algorithms in a hybrid system. In this paper, a single MPPT controller is proposed to extract maximum power from both the sources simultaneously. The performance of the proposed MPPT control algorithm is analyzed in both standalone and grid connected modes, under different weather conditions. The hybrid renewable energy system is designed by considering 560 W PV system and 500 W wind system with conventional Boost converter and it is simulated in Matlab/Simulink environment to analyze the performance of proposed MPPT controller.

Index Terms—Boost Converter, Hybrid Renewable Energy System, MPPT, RBFN, Solar Energy, Wind Energy

I. INTRODUCTION

IN the recent years, the usage of fossil fuels like coal, gas, etc., increases rapidly due to the increase in the load demand on the power system and it leads to serious problems by creating effects on the environment [1-3]. The fossil fuels may exhaust in the next few decades, due to its non-renewable nature. In spite of the availability of the energy sources, demand for electricity increasing day by day due to the modernization of the society. In order to meet this load demand, the best solution is the utilization of available renewable energy sources [4-7]. From the literature solar and the wind are the most promising renewable energy sources and its grid-tied installed capacity in India is 56% of wind source and 22% of the photovoltaic (PV) source as of April 30th, 2017 [8].

The power generation from the PV and wind systems has been increased significantly, due to its complementary available nature during a day and its output power generation will depend on the availability of solar irradiation and wind velocity respectively [9]. Due to the high penetration of renewable sources in nature, the power developed from these sources leads to intermittent and uncertain voltage. Hence, to

smoothen out these fluctuations different energy sources are to be integrated together with the help of power electronic converters to form a hybrid system and it requires a maximum power point tracking (MPPT) control algorithm to track the maximum available power from the high penetrating renewable sources [10]. Fig. 1 shows the basic block diagram topology of the hybrid system. In literature enormous number of maximum power tracking algorithms like perturb and observe (P&O), Incremental conductance, Hill climbing, Fuzzy logic controller, Neural Network and hybrid based controllers are available for extracting maximum power from the renewable PV and wind sources. Each of the maximum power tracking algorithms has its own advantages and limitations [11-13].

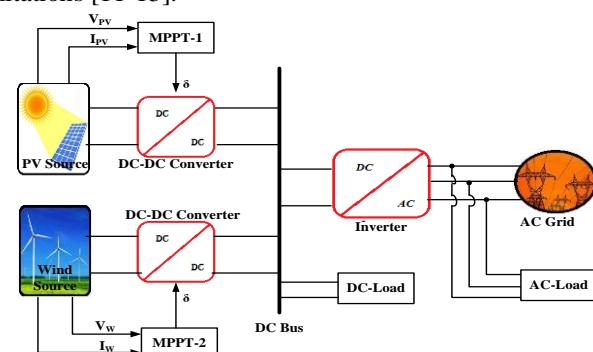

FIGURE 1. Hybrid PV and wind system basic topology

Among all available MPPT methods in the literature, P&O and Hill climbing methods are the most commonly used MPPT methods in PV and wind system [13], due to its simple structure and easy to implement. Both the methods work on the principle of perturbation by sensing voltage and current parameters from the renewable energy sources. The voltage and the duty cycle are the perturbation elements in P&O and in hill climbing methods respectively. By varying the perturbation element, it calculates the change in power and compares with the previous values for obtaining the maximum power from the source. But it has the limitation in the effective tracking of maximum power point under variable weather condition.

Incremental conductance method is another method used in both PV and wind system [11], due to its ability in handling the non-linearity characteristics to extract maximum power. It senses voltage and current from the renewable energy sources and tracks maximum power by finding the ratio between instantaneous conductance to the incremental conductance. It

Kumar K, Ramesh Babu N and Prabhu K.R are with the School of Electrical Engineering, VIT University, Vellore, Tamil Nadu, 632014 India. e-mail: ¹kumar3kk@gmail.com, ^{2*}nrameshbabu@vit.ac.in, ³prabhu.kr@vit.ac.in

is less complex and easy to implement compared to the other available MPPTs in literature.

The Fuzzy Logic controller is an artificial intelligent MPPT technique for renewable energy sources [12], it is applicable to both PV and wind system. A prior knowledge of existing weather conditions is required for designing fuzzy rules, to extracting maximum power from the renewable energy sources. In order to extract maximum power from renewable energy sources through fuzzy logic controllers, it undergoes three steps i) Fuzzification, to convert real data into fuzzy data by using membership functions, ii) Fuzzy inference system, to identify the output regions and iii) Defuzzification, to convert back to the real crisp values. It is the most suitable for rapid change in environmental conditions and it effectively tracks maximum power under partial shading weather conditions compared to the other soft computing methods.

Artificial neural network (ANN) is an intelligent control technique to track maximum power from renewable sources and it is developed by inspiring the biological human neuron [13]. The structure of the neural network consists of three layers, i) Input layer to take input data from the renewable sources like voltage, current, irradiation, temperature and wind speed data. ii) Hidden layer for adjusting the weights of the network, the better performance is achieved by adjusting the weights of the hidden neuron layer and iii) Output layer to provide output variable like duty cycle. It is one of the cost effective methods, as it requires fewer sensors. The limitation in this method is as it requires an accurate training to track the maximum power which increases the computational burden and higher complexity in extracting maximum power.

The individual MPPT control algorithms available for both PV and wind system are listed in the above literature. In a hybrid system, as a number of control algorithms increases, this in intern increases the system complexity and implementation of the system. From the discussion, each of the MPPT algorithms has its own tracking speed and characteristics. As a result, if we use different MPPT control algorithms in a hybrid renewable energy system it creates complexity on the system. To resolve the drawbacks in traditional individual MPPT controller, authors in [14-16] develops a universal MPPT control algorithm to track maximum power from both sources with same convergence time, speed and tracking efficiency.

Even through the above universal controller applicable for both PV and wind sources to extract maximum power, it requires individually dedicated MPPT algorithms for each source, which intern increases the cost, size, complexity in implementation of the hybrid system. In order to overcome the above drawbacks, an ANN based single MPPT control algorithm is proposed to extract maximum power from the high penetrating hybrid PV and wind renewable energy system concurrently. The proposed Radial Basis Function Network (RBFN) based single MPPT controller is implemented in a hybrid PV and wind system of rating 560 W PV source and 500 W of wind source with conventional Boost converter topology. The simulation results are presented to validate the simultaneous power tracking capability of the proposed MPPT control algorithm.

The rest of the paper is organized as follows, in Section-2, the design of hybrid PV and wind system. In Section-3, the

proposed RBFN based single MPPT algorithm and in Section-4, simulation and result discussion, followed by conclusion Section-5.

II. DESIGN OF HYBRID PV AND WIND SYSTEM

A hybrid system is designed by integrating the both PV and wind energy sources with the individually dedicated Boost converters. The PV system is fed to the DC-DC Boost converter and the output of the wind system is rectified by diode bridge rectifier and then fed to the DC-DC converter. Both the sources are integrated together at the common DC link bus capacitor to make a hybrid system. The Fig. 2 shows the schematic diagram of the proposed hybrid energy system with proposed single MPPT. In this proposed MPPT control algorithm, the maximum power from the both the sources (PV and wind) are extracted by executing the tracing algorithm concurrently. The modeling of PV system, wind system and design of basic Boost converter is presented in following subsections.

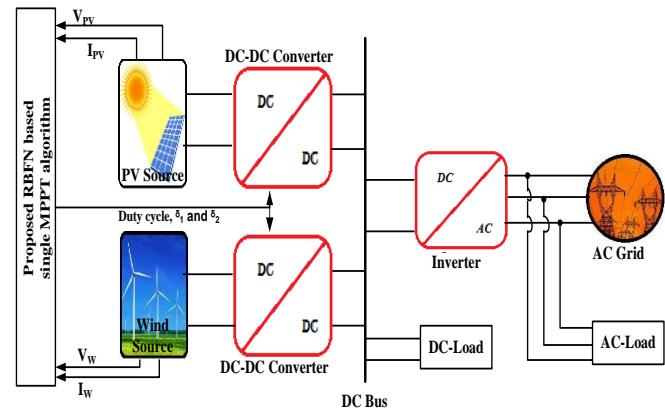

FIGURE 2. Proposed single MPPT topology for hybrid PV and wind system

A. PV System

The design of PV model for making hybrid renewable energy system is presented in this subsection. In this paper, a single diode model PV cell is considered as shown in Fig. 3(a) and its symbolic representation is shown in Fig. 3(b). The mathematical modeling of the PV system is derived from the basic I_{PV} - V_{PV} characteristics of PV panel.

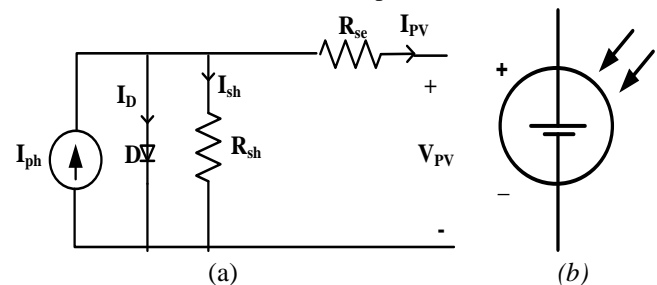

FIGURE 3. PV cell single diode model (a) equivalent circuit, (b) Symbolic representation

The basic equations for deriving the PV panel output voltage and current are given in Eq. (1) and (2) respectively. [17,18]

$$V_{pv} = \frac{\eta KT}{q} \ln \left(\frac{I_{ph}}{I_{pv}} + 1 \right) \quad (1)$$

$$I_{pv} = I_{ph} - I_{pvrsc} \left(e^{\frac{q(V_{pv} + I_{pv}R_{se})}{\eta KT}} - 1 \right) - \frac{V_{pv} + I_{pv}R_{se}}{R_{sh}} \quad (2)$$

The PV output power depends on the availability of solar irradiations and temperature in the environment and it is calculated by using Eq. (3) [19]

$$P_{PV} = A_{PVP} G_n \eta_{PVP} \quad (3)$$

The series and shunt resistances for single diode model are calculated by using Eq. (4) and (5) [20].

$$R_{se} = 0.09 \frac{V_{oc}}{I_{sc}} \quad (4)$$

$$R_{sh} = 11 \frac{V_{oc}}{I_{sc}} \frac{G}{G_n} \quad (5)$$

where, V_{pv} : PV panel output voltage (V)

R_{sh} : Shunt resistance of single diode model (Ω)

I_{ph} : PV Cell phase current (A)

V_{oc} : Open circuit voltage of PV panel (V)

I_{sc} : Short circuit current of PV panel (A)

R_{se} : Series resistance of single diode model (Ω)

η : Ideality factor

q : Electron charge (1.60217×10^{-19} C)

η_{PVP} : PV panel generation efficiency (%)

A_{PVP} : PV panel area (m^2)

K : Boltzman constant of PV panel (1.38×10^{-23} J/K)

T : Ambient temperature (K)

G : Applied solar irradiations to the PV panel

G_n : Nominal irradiation to the PV panel

I_{pv} : PV panel output current (A)

I_{pvrsc} : Reverse saturation current (A)

A hybrid renewable energy system is designed by considering 560 W BP Solar SX3190 PV module and its design specification of is listed in the Table. 1

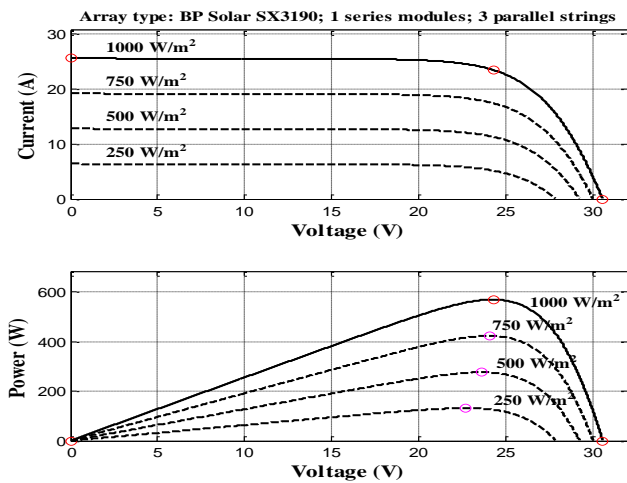

FIGURE 4. I-V and P-V Characteristics of BP Solar SX3190 model

Fig. 4 shows the I-V and P-V characteristics for BP SX3190 PV module based on the availability of solar irradiation. It is observed that the generated PV maximum output power will depend on the availability of solar irradiations and temperature.

TABLE 1. Parameter Specifications of BP Solar SX3190 PV Module

Parameter Description	Rating
Maximum power (P_{MP})	560 W
Maximum current (I_{MP})	7.82945 A
Maximum voltage (V_{MP})	24.3003 V
Short circuit current (I_{SC})	8.51029 A
Temperature (T)	25 ⁰ C
Open circuit voltage (V_{oc})	30.6021 V
Parallel strings	3
Series-connected modules per string	1
Solar irradiation (G)	1000 W/m ²

B. Wind Energy System

The modeling of wind energy system depends on modeling of the wind turbine and electric generator. Wind velocity is given as input to the wind turbine and it produces mechanical power as an output. The total mechanical output power produced by the wind turbine is derived from the Eq. (6) and it is the cube of the wind velocity [17,21].

$$P_m = \frac{1}{2} \rho A V_v^3 \quad (6)$$

where P_m : Wind output power

A : Swept area of wind blade

V_v : Velocity of the wind (m/sec)

ρ : Air density (Kg/m^3)

The Aeolos-H 500W wind turbine is considered for the design of the hybrid system and its parameter specifications are listed in Table 2.

TABLE 2. Parameter specifications of Aeolos-H 500 W wind system

Description	Rating
Power (P)	500 W
Impedance (R_a)	0.775 Ω
Inductance (L_q and L_d)	7.31 mH
Magnetizing flux (Φ_m)	0.37387 wb
Coefficient of friction (B)	0
Pair of Poles (P_p)	2
Torque/Current (T/A)	1.1216 Nm/A
Cut-in wind speed (V_d)	4 m/s
Moment of inertia (J)	0.00126811 kg/m ²
Rated wind speed (V_n)	12 m/s (26.8 mph)

The Fig. 5 shows the characteristics of the wind turbine power generation system at different wind velocity data's [18] and the total power produced by the wind energy system is derived from Eq. (7) [18,22]. It is observed that , the output wind power depends on the availability of the wind velocity.

$$P_w(V_v) = \begin{cases} P_n \frac{V_v^2 - V_d^2}{V_n^2 - V_d^2} & ; V_d < V_v < V_n \\ P_n & ; V_n < V_v < V_c \\ 0 & ; V_v \leq V_d \text{ and } V_v \geq V_c \end{cases} \quad (7)$$

where, P_w : Output power (W)

V_d : Cut-in wind speed (m/s)

P_n : Nominal power (W)

V_n : Rated wind speed (m/s)

V_v : Wind velocity (m/s)

V_c : Cut-off wind speed (m/s)

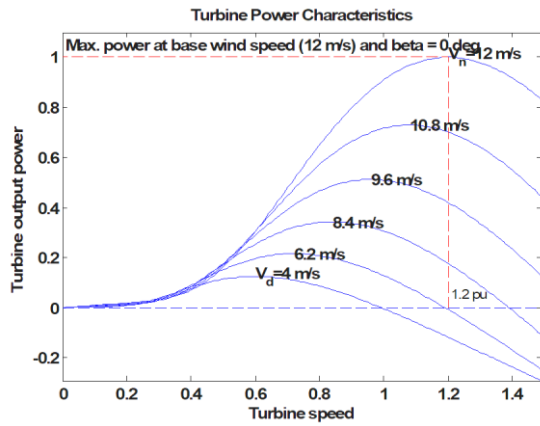

FIGURE 5. Wind turbine power characteristics of Aeolos-H 500W system

C. DC-DC Boost Converter

The conventional DC-DC Boost converter is considered to connect the PV source and wind system to the common DC link capacitor, due to its simple structure with fewer converter components, higher conversion efficiency and capable of converting low renewable source voltage to desired value by changing the duty cycle at a higher switching frequency rate [23].

It consists of the single semiconductor switch (S_1), a single diode (D_1), two energy storage elements inductor (L_1) and capacitor (C_1) as shown in Fig. 6 for each source. The key principle for the operation of Boost converter depends on the inductor, L. Its output voltage is always much higher than the input source voltage [24]. The output voltage, current, and voltage transfer gain are given in Eq. (8), (9) and (10) respectively.

The output voltage, current and transfer gain of the Boost converter [25] are expressed as,

$$V_o = \left(\frac{1}{1-D} \right) V_{pv} \tag{8}$$

$$I_o = \left(\frac{1}{1-D} \right) I_{pv} \tag{9}$$

$$M = \frac{V_o}{V_{pv}} = \frac{1}{1-D} \tag{10}$$

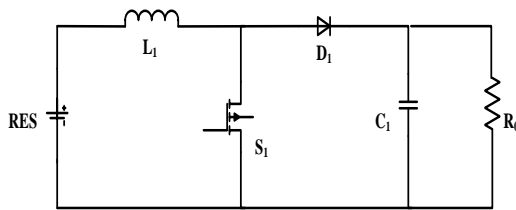

FIGURE 6. Equivalent circuit of conventional Boost converter

Where, V_o is output voltage

I_o is output current

V_{pv} is PV output voltage

I_{pv} is PV output current

D is duty cycle

M is voltage transfer gain

The Boost converter simulation parameters are listed in Table. 3 and its theoretical switching waveform are shown in Fig. 7.

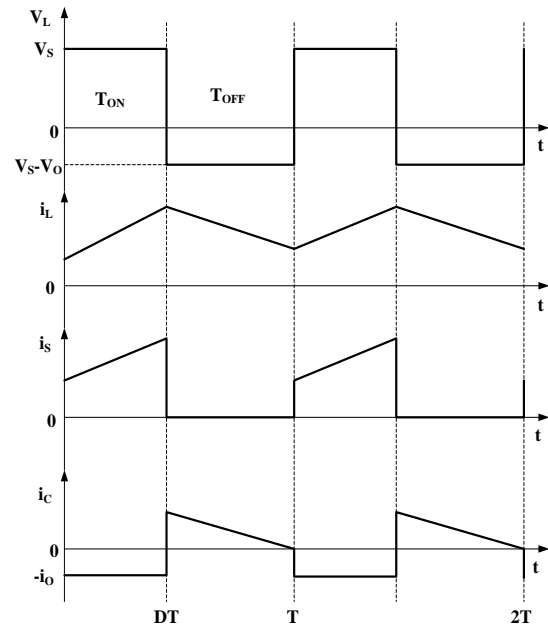

FIGURE 7. Switching waveform of Boost Converter

TABLE 3. Boost converter parameter specifications

Description	Ratings
Input voltage, V_{in}	24 V
Output voltage, V_{out}	230 V
Boost inductor, L	$16 e^{-3}$ H
DC link capacitors, C	$4.82 e^{-6}$ F
Load resistance, R	97.5 Ω
Switching frequency, f_s	20 kHz

III. IMPLEMENTATION OF PROPOSED RBFN BASED SINGLE MPPT

MPPT algorithm is necessary for both PV and wind system, to yield maximum possible power from the dynamic wind speed and solar irradiation conditions. Amongst all the available MPPT algorithms in the literature, the most popular tracking algorithm are P&O, Hill climbing, Incremental conduction methods, due to its simple structure and easy to implement [4]. These methods are having drawbacks of fixed step size and cause high power oscillations in the maximum power point. Fuzzy and Neural Network methods are most suitable maximum power tracking methods for the hybrid renewable energy systems, due to its ability to solve non-linear problems.

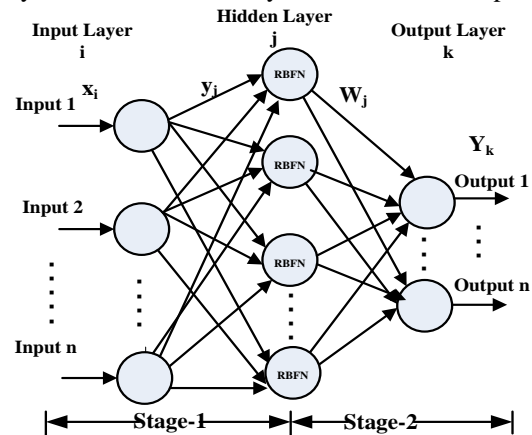

FIGURE 8. Architecture of RBFN

In this hybrid renewable energy system, RBFN based intelligent MPPT controller is considered to track maximum power from both the PV and wind energy system. The basic architecture of RBFN based network is shown in Fig. 8. The performance of the RBFN network depends on the interconnection pattern, weights and activation function present in the system. It requires an individual MPPT controller for each renewable energy sources, which increases the size and complexity in system implementation. Hence, this two MPPT's control algorithms are integrated together in the modified single RBFN based single MPPT controller. The architecture of the modified single RBFN MPPT controller is as shown in Fig. 9. The orthogonal least square (OLS) learning algorithm is used to train the RBFN based MPPT network. The input variables to the input layer for the proposed MPPT are V_{PV} , V_w , I_{PV} and I_w .

(Step-1) The input layer consists of four input neurons to read the input data, the net input and output of the input neuron are given in Eq. (11) and (12).

$$x_i^{(1)}(n) = net_i^{(1)} \quad (11)$$

$$y_i^{(1)}(n) = f_i^{(1)}(net_i^{(1)}(n)) = net_i^{(1)}(n), \quad i = 1,2,3,4 \quad (12)$$

(Step-2) The Gaussian membership function is considered for each neuron in hidden layer, the net input and output of the hidden neuron is given in Eq. (13) and (14).

$$net_j^{(H)}(n) = -(X - M_j)^T \sum_j (X - M_j) \quad (13)$$

$$y_j^{(H)}(n) = f_j^{(H)}(net_j^{(H)}(n)) = \exp(net_j^{(H)}(n)), \quad j = 1,2,3,\dots \quad (14)$$

(Step-3) The output layer consists of two neurons, to generate two different control signals D_{pv} and D_w for PV and wind system with a linear activation function, the net input and output of the output neuron are given in Eq. (15) and (16).

$$net_k^{(O)}(n) = \sum_j w_j y_j^{(H)}(n) \quad (15)$$

$$y_k^{(O)}(n) = f_k^{(O)}(net_k^{(O)}(n)) = net_k^{(O)}(n) \quad (16)$$

Where, $x_i^{(1)}$ is input layer, $net_i^{(1)}(n)$ is the sum of the input layer, $net_i^{(H)}(n)$ is sum of the hidden layer, $net_i^{(O)}(n)$ is the sum of the output layer, W_j is the weights between hidden and output layer, M_j and \sum_j are the Mean and standard deviation of the output layer.

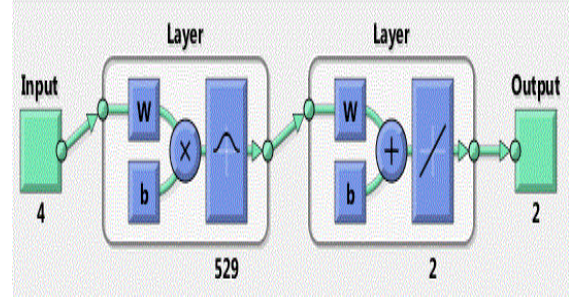

FIGURE 9. RBFN based single MPPT architecture for hybrid system

IV. SIMULATION AND RESULT DISCUSSION

To inspect the suitability of proposed single MPPT controller feature, firstly standalone hybrid PV and wind system with conventional Boost converter is considered and simulated in the MATLAB/Simulink environment, later it is integrated to the 230 V, 50 Hz AC grid as shown in Fig. 10. To test the suitability of the proposed single MPPT controller for extracting maximum power from the renewable energy sources. A hybrid system with conventional Boost converter is implemented by using the parameters listed in Table. 3 and the specifications of the PV panel and wind system are listed in Table 1 and 2 respectively.

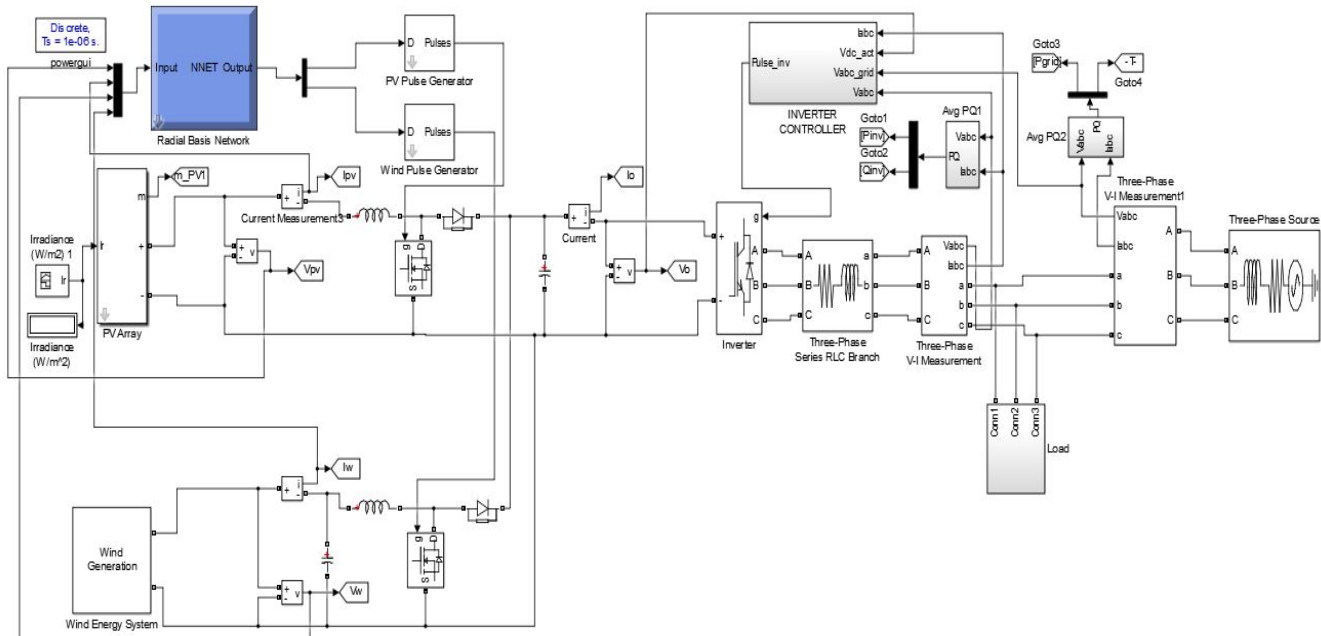

FIGURE 10. Simulation of hybrid system with single MPPT

A. Standalone System

The Simulink model of the hybrid PV and Wind system with individual Boost converter along with the proposed single MPPT control algorithm is shown in Fig. 10. It takes V_{PV} , V_W , I_{PV} and I_W as input variables for the MPPT controller and gives the different duty cycles for each switch, to extract maximum power from each source concurrently. The availability of solar irradiation of the proposed system are considered as follows: $G= 600 \text{ W/m}^2$ for a period of 0 to 0.3 sec , $G= 800 \text{ W/m}^2$ for a period of 0.3 to 0.6 and $G= 1000 \text{ W/m}^2$ for a period 0.6 to 0.9 by assuming 40%, 20% and 0% shading effect on the solar irradiation respectively as in Fig. 11.

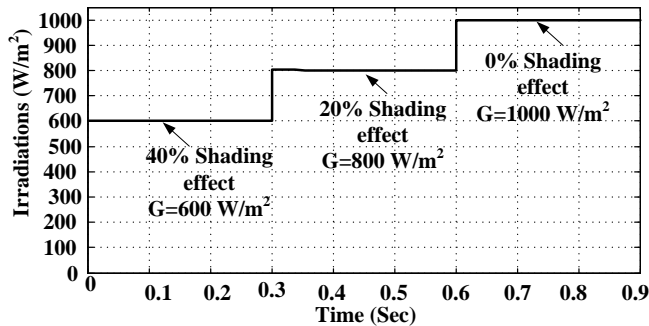

FIGURE 11. Considered solar irradiation pattern for PV system

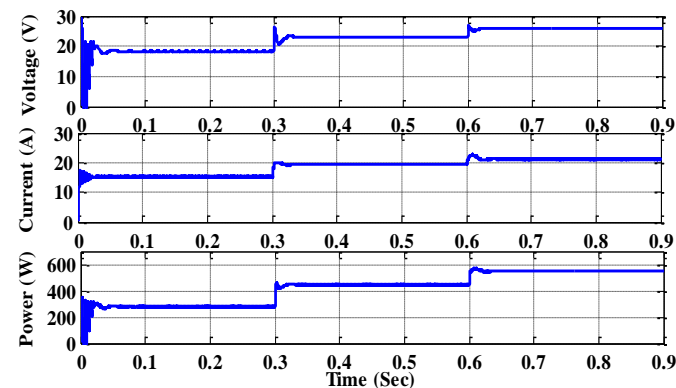

FIGURE 12. PV panel output voltage, current, and power at different irradiation levels

The PV panel output voltage, current and power waveforms are shown in Fig. 12, as per the consideration of available solar irradiation. It gives 324 W for a period of 0 to 0.3 sec, as the availability of solar irradiations is 600 W/m^2 , similarly, 436.8 W and 554.4 W for a period 0.3 to 0.6 sec and 0.6 to 0.9 sec respectively depends on the availability of the solar irradiations.

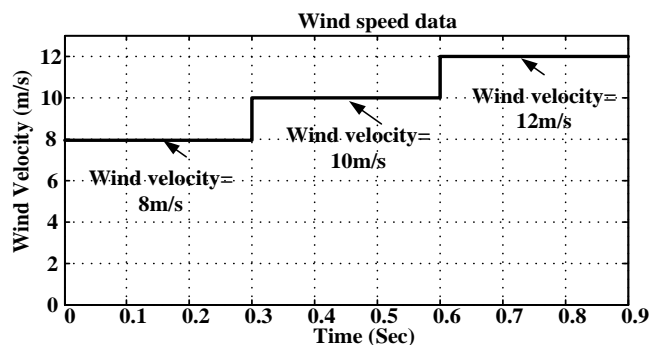

FIGURE 13. Considered wind velocity data pattern for wind system

The availability of the wind velocity data for the developed system are considered as follows for a period 0 to 0.3 sec as 8 m/s, 0.3 to 0.6 sec as 10 m/s and for the period 0.6 to 0.9 sec as rated wind speed 12 m/s as clearly shown in Fig. 13.

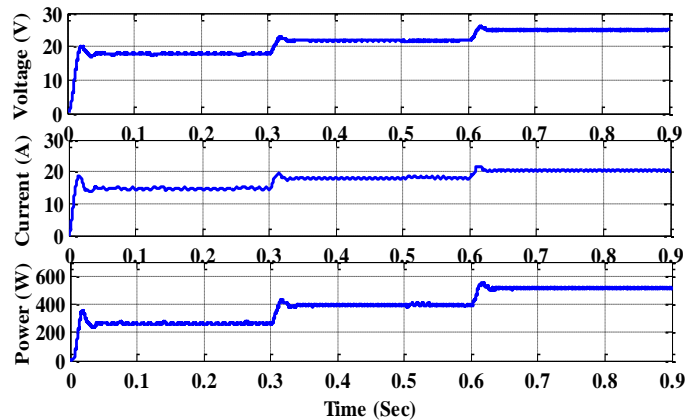

FIGURE 14. Wind system output voltage, current, and power at different wind velocity levels

The wind system output voltage, current and power waveforms are shown in Fig. 14, as per the consideration of the availability of the wind speed data. It gives 318 W for a period of 0 to 0.3 sec, as the availability of wind data is 8 m/s, similarly 392 W and 493 W for a period 0.3 to 0.6 sec and 0.6 to 0.9 sec respectively depends on the availability of the wind data.

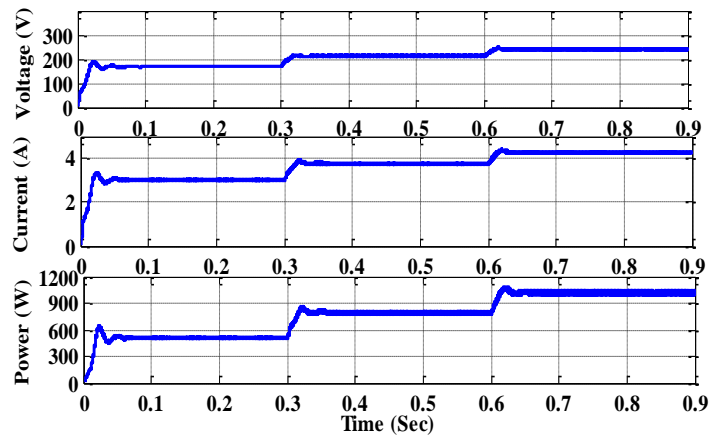

FIGURE 15. Output DC link capacitor voltage, current, and power

Fig. 15 shows the hybrid PV and wind system DC link output voltage, current and power waveforms as per the consideration of available input data from each source. The developed hybrid system with single MPPT gives the average DC link power of 587 W for a period of 0 to 0.3 sec (with PV 600 W/m^2 and wind 8 m/s), 721 W for a period of 0.3 to 0.6 sec (with PV 800 W/m^2 and wind 10 m/s) and 858.8 W for a period of 0.6 to 0.9 sec (with PV 1000 W/m^2 and wind 12 m/s). The performance of the proposed RBFN controller is compared with the modified single P&O MPPT technique [26] as listed in Table 4. From the comparison, we observed that the proposed single RBFN based MPPT technique produces the higher power compared to the single P&O MPPT technique.

TABLE 4.Comparative analysis of hybrid PV and wind system with different MPPT techniques

	Hybrid PV and wind system with modified P&O based single MPPT			Hybrid PV and wind system with RBFN based single MPPT		
	0 to 0.3	0.3 to 0.6	0.6 to 0.9	0 to 0.3	0.3 to 0.6	0.6 to 0.9
Period (Sec)	0 to 0.3	0.3 to 0.6	0.6 to 0.9	0 to 0.3	0.3 to 0.6	0.6 to 0.9
Input Solar irradiations W/m ²	600	800	1000	600	800	1000
Input Wind velocity m/s	8	10	12	8	10	12
Voltage (V)	158	194.8	229	162	197.3	229
Current (A)	3.56	3.62	3.65	3.62	3.66	3.76
Power (W)	563	705.2	837.4	587	721	858.8

B. Grid Connected System

To validate the proposed single MPPT controller, a grid connected hybrid renewable energy system is implemented in Matlab/Simulink model by considering the load of 1000 W active power and 800 VAR reactive powers, with AC grid of rating 230 V, 50 Hz. The common DC link power is fed to the three phase inverter and its current regulated controller is shown in Fig. 16. The obtained V_{dc} and Q_{inv} are compared with the reference values and the error is feed to the PI controller which is further used to generate the firing angle. The output voltage, current of the inverter, load and grid are shown in Fig. 17 to 19 respectively. The active and reactive powers of load, inverter, and grid are shown in Fig. 20 to 21 respectively.

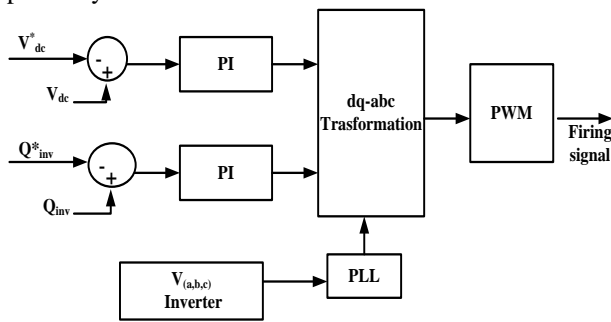

FIGURE 16. Grid side current regulated controller

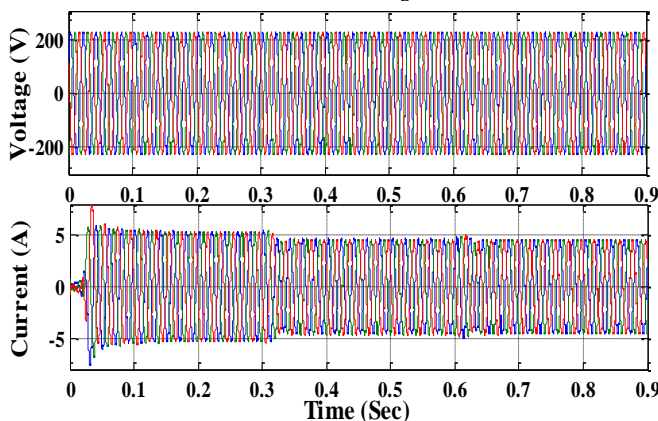

FIGURE 17. Inverter voltage, current

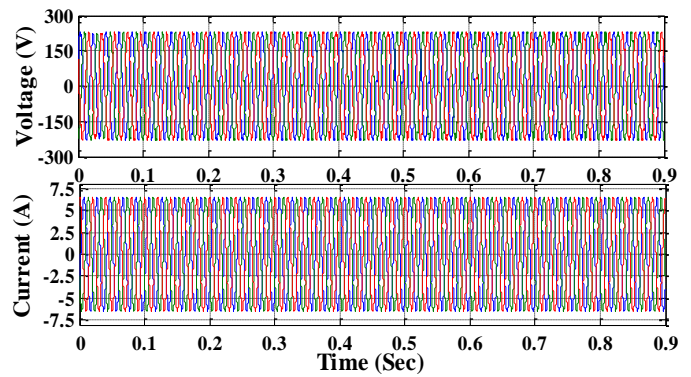

FIGURE 18. Load voltage, current

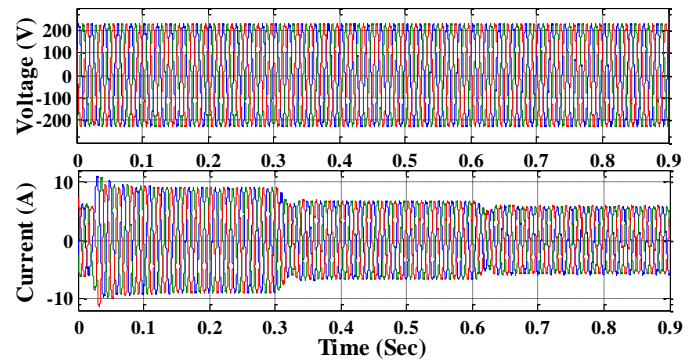

FIGURE 19. Grid voltage, current

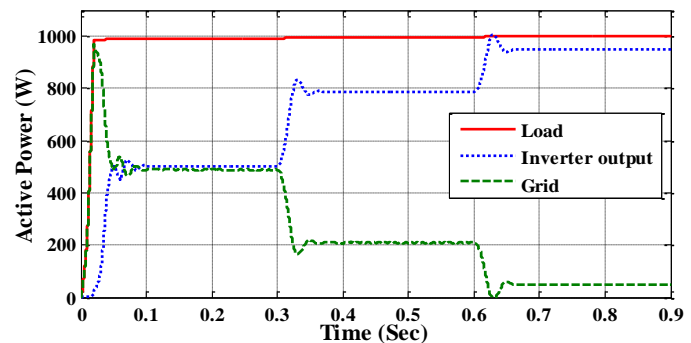

FIGURE 20. Active power

The Fig. 20 represents the active power profile of the load, grid and inverter outputs. The considered active power load demand of 1000 W is supplied by the both hybrid system and grid depends on the availability of the renewable input data. For a period of 0 to 0.3 sec, load demand is satisfied by the both hybrid and grid sources with 563 W and 428 W respectively, similarly for a period of 0.3 to 0.6 sec with hybrid system contribution of 697 W and from grid source contribution of 299 W and for period of 0.6 to 0.9 sec with contribution of 822 W from hybrid system and 176 W from grid. The Fig. 21 represents the reactive power profile of the load, grid and inverter outputs. The considered reactive power load demand of 800 VAR is supplied by the both hybrid system and grid depends on the availability of the renewable input data as listed in Table 5.

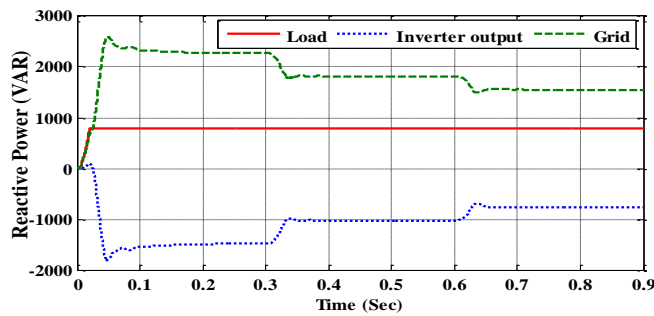

FIGURE 21. Reactive power

TABLE 5. Active and Reactive power for the developed hybrid PV and wind energy system

Period (Sec)	Active Power (W)			Reactive Power (VAR)		
	0 to 0.3	0.3 to 0.6	0.6 to 0.9	0 to 0.3	0.3 to 0.6	0.6 to 0.9
Inverter output (W)	563	697	822	-463	-263	4.35
Grid (W)	428	299	176	1261	1060	794
Load (W)	991	996	998	793	796	799

V. CONCLUSION

In this paper, an RBFN based single MPPT controller was introduced for hybrid PV and wind system. The various MPPT methods available in the literature for extracting maximum power in the hybrid system are discussed. The proposed single MPPT controller is implemented in hybrid renewable energy system consists of 560 W PV system and 500 W wind system incorporated with the Boost converter to track maximum power from both the sources concurrently. The performance of the developed MPPT is analyzed in both standalone and grid connected modes by considering the change in solar irradiations and wind speed data with respective time. The simulation results are presented with a modified single MPPT for both the sources under different solar irradiations and wind speed conditions. The developed standalone hybrid system with single MPPT gives the average power 587 W for a period of 0 to 0.3 sec (with PV 600 W/m² and wind 8 m/s), 721 W for a period of 0.3 to 0.6 sec (with PV 800 W/m² and wind 10 m/s) and 858.8 W for a period of 0.6 to 0.9 sec (with PV 1000 W/m² and wind 12 m/s). The obtained results are compared with the single P&O MPPT technique, which reveals proposed RBFN based single MPPT, gives the best result. To validate the grid capability of the proposed controller, the active and reactive powers are presented in this paper. The modified MPPT effectively tracks the maximum power from both sources concurrently, which reduces the complexity in implementation of the hybrid system.

REFERENCES

- [1] Kumar, K., N. Ramesh Babu, and K. R. Prabhu. "Design and Analysis of an Integrated Cuk-SEPIC Converter with MPPT for Standalone Wind/PV Hybrid System." *Int. J Renewable Energy Research*, vol. 7, no. 1, pp. 96-106, 2017.
- [2] Wu, Gang, XinboRuan, and Zhihong Ye. "Non isolated high step-up dc-dc converters adopting switched-capacitor cell." *IEEE Trans. Ind. Electron.*, vol. 62, no. 1, pp. 383-393, 2015.
- [3] Saravanan, S., and N. Ramesh Babu. "Modified High Step-Up Coupled Inductor based DC-DC Converter for PV Applications." *Gazi Univers. J Sci.*, vol. 29, no. 4, pp. 981-986, 2016..
- [4] Saravanan, S., and N. Ramesh Babu. "RBFN based MPPT algorithm for PV system with high step up converter." *Energy Convers. Manag.*, vol. 122, pp. 239-251, 2016.

- [5] Liang, Tsorng-Juu, Jian-Hsieng Lee, Shih-Ming Chen, Jiann-Fuh Chen, and Lung-Sheng Yang. "Novel isolated high-step-up DC-DC converter with voltage lift." *IEEE Trans. Ind. Electron.*, vol. 60, no. 4, pp. 1483-1491, 2013.
- [6] Sitbon, M., Schacham, S., Suntio, T., &Kuperman, A. "Improved adaptive input voltage control of a solar array interfacing current mode controlled boost power stage." *Energy Convers. Manag.*, vol. 98, pp. 369-375, 2015.
- [7] Lotfy ME, Senjyu T, Farahat MA, Abdel-Gawad AF, Yona A. "Enhancement of a Small Power System Performance Using Multi-Objective Optimization", *IEEE Access*, vol. 5, pp. 6212-6224, 2017.
- [8] Cumulative development of various renewable energy system/ devices in country, Retrieved from <http://mnre.gov.in/mission-and-vision-2/achievements>
- [9] Pathan NT, Adhau SP, Adhau PG, Sable MM. "MPPT for grid connected Hybrid Wind Driven PMSG-Solar PV Power Generation System with Single Stage Converter". *J Electric Power Sys Engineering*, vol. 3, no. 1, pp. 41-59, 2017.
- [10] Li, Shengquan, and Juan Li. "Output Predictor based Active Disturbance Rejection Control for a Wind Energy Conversion System with PMSG." *IEEE Access*, 2017.
- [11] Ram JP, Rajasekar N, Miyatake M. "Design and overview of maximum power point tracking techniques in wind and solar photovoltaic systems: A review", *Renew. Sustain. Energy Rev.*, vol. 73, pp. 1138-1159, 2017.
- [12] Tiwari R, Babu NR. Recent developments of control strategies for wind energy conversion system, *Renew. Sustain. Energy Rev.*, vol. 66, pp. 268-85, 2016.
- [13] Saravanan S, Babu NR. "Maximum power point tracking algorithms for photovoltaic system-A review", *Renew. Sustain. Energy Rev.*, vol. 57, pp. 192-204, 2016.
- [14] Fathabadi H. "Novel highly accurate universal maximum power point tracker for maximum power extraction from hybrid fuel cell/photovoltaic/wind power generation systems". *Energy*, vol. 116, pp. 402-16, 2016.
- [15] Fathabadi H. "Novel fast and high accuracy maximum power point tracking method for hybrid photovoltaic/fuel cell energy conversion systems". *Renew. Energy*, vol. 106, pp. 232-242, 2017.
- [16] Fathabadi, Hassan. "Novel high-efficient unified maximum power point tracking controller for hybrid fuel cell/wind systems." *Appl. Energy*, vol. 183, pp. 1498-1510, 2016.
- [17] Hong, Chih-Ming, and Chiung-Hsing Chen. "Intelligent control of a grid-connected wind-photovoltaic hybrid power systems." *Int. J Electric. Power & Energy Sys.*, vol. 55, pp. 554-561, 2014.
- [18] Baghdadi, Fazia, Kamal Mohammadi, Said Diaf, and Omar Behar. "Feasibility study and energy conversion analysis of stand-alone hybrid renewable energy system." *Energy Convers. Manag.*, vol. 105, pp. 471-479, 2015.
- [19] Bhandari B, Poudel SR, Lee KT, Ahn SH. "Mathematical modeling of hybrid renewable energy system: A review on small hydro-solar-wind power generation". *Int. J precision engineering and manufacturing- greentechnol.*, vol. 1, no. 2, pp. 157-73, 2014.
- [20] Kwan, Trevor Hocksun, and Xiaofeng Wu. "Maximum power point tracking using a variable antecedent fuzzy logic controller." *Sol. Energy*, vol. 137, pp. 189-200, 2016.
- [21] Kabalci, Ersan. "Design and analysis of a hybrid renewable energy plant with solar and wind power." *Energy Convers. Manag.*, 72:51-59, (2013).
- [22] Dhrab, Salwan S., and Kamaruzzaman Sopian. "Electricity generation of hybrid PV/wind systems in Iraq." *Renew. Energy*, vol. 35, no. 6, pp. 1303-1307, 2010.
- [23] Kirubakaran A, Jain S, Nema RK. "The PEM fuel cell system with DC/DC boost converter: design, modeling and simulation". *Int. J recent trends in Engineering*, vol. 1, no. 3, pp. 157-161, 2009.
- [24] Nejabatkhah F, Danyali S, Hosseini SH, Sabahi M, Niapour SM. "Modeling and control of a new three-input DC-DC boost converter for hybrid PV/FC/battery power system". *IEEE Trans.PowerElectron.*, vol. 27, no. 5, pp. 2309-24, 2012.
- [25] Revathi, B. Sri, and M. Prabhakar. "Non isolated high gain DC-DC converter topologies for PV applications-A comprehensive review." *Renew. Sustain. Energy Rev.*, vol. 66, pp. 920-933, 2016.
- [26] Kumar, K., N. Ramesh Babu, and K. R. Prabhu. "Design and Analysis of Modified Single P&O MPPT Control Algorithm for a Standalone Hybrid Solar and Wind Energy Conversion System." *Gazi Univers. J Sci.*, (Under revision)