

PAPER • OPEN ACCESS

Disturbance Analysis and Implementation of High Voltage Gain Non-Isolated DC-DC Converter for Renewable Applications

To cite this article: T Arunkumari *et al* 2019 *IOP Conf. Ser.: Mater. Sci. Eng.* **623** 012008

View the [article online](#) for updates and enhancements.

A promotional banner for the ECS 240th Meeting. The banner features a colorful striped border at the top. On the left, the ECS logo is displayed in a green circle. To its right, the text reads "240th ECS Meeting" in large blue font, followed by "Oct 10-14, 2021, Orlando, Florida" in a smaller black font. Below this, it says "Register early and save up to 20% on registration costs" in bold black text, and "Early registration deadline Sep 13" in a smaller black font. At the bottom left, there is a red "REGISTER NOW" button. On the right side of the banner, there is a photograph of a diverse group of people in a professional setting, with a man in a white shirt and tie clapping and smiling.

Disturbance Analysis and Implementation of High Voltage Gain Non-Isolated DC-DC Converter for Renewable Applications

Arunkumari T¹, Indragandhi V^{2*}, Vikramjeet Singh Sidhu³, K T M Udayanga Hemapala⁴

^{1,2,3}School of Electrical Engineering, Vellore Institute of Technology, Vellore, India

⁴Department of Electrical Engineering, University of Moratuwa, Sri Lanka

Corresponding Author: indragandhi.v@vit.ac.in

Abstract. A modified high gain single switch high-voltage converter is presented in this paper. The proposed converter is a blend of a voltage tripler and a SEPIC-boost mode converter. Its operational modes are presented in detail. This converter has advantages that include a single switch, reduced component stress and size, and reduced ripple output voltage and input ripple current. The simulation results of the suggested converter and a conventional multilevel SEPIC converter are presented. The prototype of a 30 V to 400 V input, 400 W output is developed and the performance of the designed topology is evaluated. The theoretical and experimental results conclude that this converter is suitable for high-voltage applications.

Index Terms—High voltage gain, SEPIC- boost mode converter, Ripple, Voltage Tripler.



1. Introduction

Converters and inverters play a vital role in converting renewable energy to electrical energy [1-4]. The PV energy output has low voltage, hence to step up the voltage, high ratio converters are used. High voltage step-up PV energy is utilized for industrial, residential, and grid connection purposes. DC-DC converters are of two types, with and without Transformer. As transformer introduces loss, non-isolated converters are often found to be better suited for PV energy conversion [5]. Hence, non-isolated boost, buck, and buck-boost converters are preferred for conversion. The boost converter is utilized for high voltage conversion with large duty cycles but is highly stressful to the switch affecting the conversion efficiency [6].

To improve the conversion ratio, various high gain topologies such as dual boost converters, Single-Ended Primary Inductor Converter (SEPIC), Cuk converters, etc. [7-12]. Different techniques have been used to improve the voltage conversion ratio, such as switched capacitor technique, coupled inductive method, voltage lift technique, etc., but are replete with drawbacks such as high voltage stress on the switch, pulsating input current, complexity of the circuit, and high cost of the components [13-14].

These techniques have been combined with normal boost converters and quadratic converters. However, the focus is on SEPIC converters as their performance is better than other converters. SEPIC converter has been reported to be better than conventional boost converters in terms of efficiency and transient response. The SEPIC converter is utilized to bring down reverse recovery loss and to enhance the power factor correction [15]. In a study, the SEPIC converter was implemented with voltage lift technique and obtained a positive-positive DC voltage with high conversion gain [16]. In [17-18] the SEPIC converter was combined with high frequency transformer to sustain the inductor current during the conduction period.

The SEPIC-Integrated Boost converter (SIB), a combination of SEPIC and boost, was designed to improve the PV voltage ratio. SIB was found capable to reduce the diode loss and reverse recovery current [19-20]. The SEPIC converter using voltage multiplier technique was suggested in some studies [21-24]. The modified sepic converter has been proposed in [25] and here in this manuscript the extension along with load and line disturbance analysis is proposed.

To overcome these drawbacks, a non-isolated modified high gain SEPIC converter with a single switch design is proposed here. The benefits of the proposed converter are a high voltage conversion ratio, low switching voltage, reduced output ripple current, low duty control, lesser number of components, easy control, and cost effectiveness compared to other converters. The proposed modified high gain SEPIC converter is depicted in Fig. 1. The presented converter provides 400 W from input of 30 V.

This paper is structured as follows: Section II details the operation of the proposed converter with Continuous Conduction Mode (CCM), in section III the simulation results are explained. Section V discusses the disturbance analysis results, and Section VI concludes the work.

2. Operating principle

The high gain SEPIC converter proposed is shown in Fig.1. Following are some of the assumptions made to simplify the circuit design and operation of the proposed converter:

- 1) The converter operates under Continuous Conduction Mode at the steady state condition.
- 2) Semiconductor devices are considered to be ideal in nature.
- 3) The capacitor utilized has high storage voltage, therefore it is assumed to be constant.

The converter design consists of main switch S_1 , inductors L_1, L_2 , diodes D_1 to D_6 , capacitors C_1 to C_5 , and output capacitor C_6 . The Voltage Tripler (VT) circuit is combined with the SEPIC converter to increase the voltage gain of the converter. The switching voltage in the semiconductor device is kept reduced. The proposed converter operation in CCM mode is explained below.

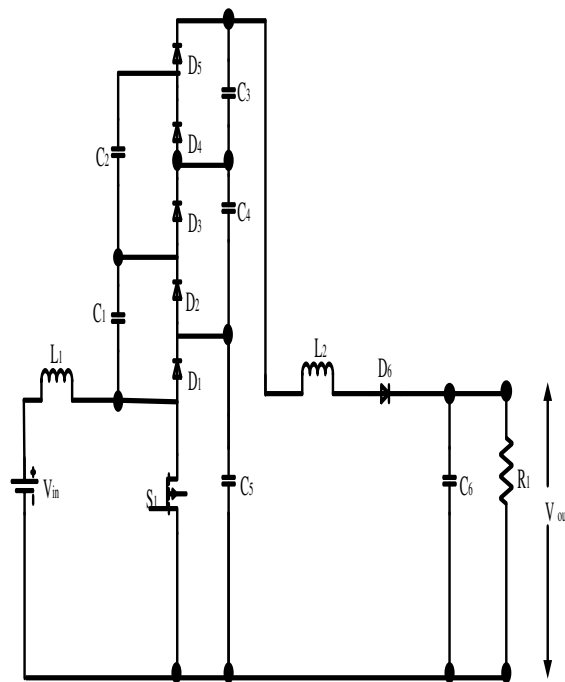
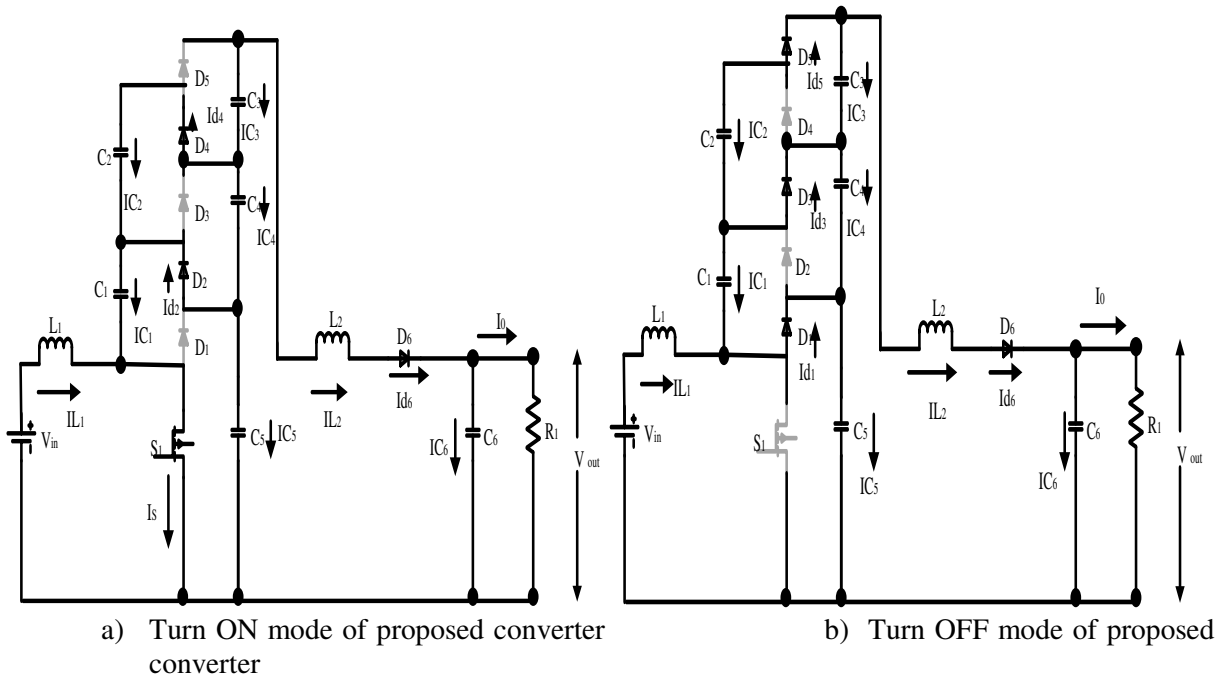

Figure.1 Proposed single switch DC-DC Converter

2.1. Continuous conduction mode operation

The proposed converter functions in two modes as shown in Figs. 2 a) and b)

Mode I [t0–t1]: As the switch S_1 is switched ON, diodes $D_2, D_4,$ and D_6 are turned ON. Diode D_1, D_3 and D_5 are reverse biased. The voltage V_{in} is delivered to L_1 and $V_{C3} - V_{C2} - V_{C1}$ is delivered to L_2 . These inductors help in storing the energy. The output capacitor C_6 discharges the energy required to the load for its operation. With the switch OFF, this mode ends. Also, the current in diode D_1 and D_3 attain zero at $t=t_1$.



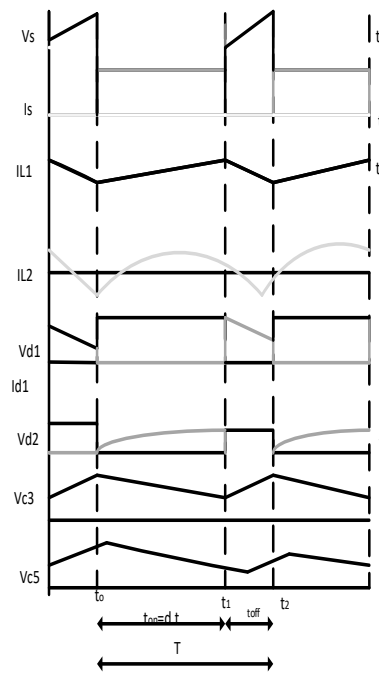

b) CCM operation waveforms
Figure.2 a,b,c Modes Of Operation

Mode II [t1–t2]: With the switch S_1 turned OFF, the diodes D_2 and D_4 are in OFF condition. The diodes D_1, D_3 and D_5 are in forward condition. The inductors L_1 and L_2 charge the capacitors. The load receives the energy by discharging mode of the capacitor. This operation proceeds with the switch turned ON. This continues to the next cycle. The main operational waveform is represented in Fig. 2 c). The total capacitive voltage equals the output voltage of the converter.

$$V_{C6} = V_{C3} + V_{C4} + V_{C5} \quad (1)$$

3. Simulation results and analysis

In this section, the simulation results of the proposed converter are explained. The input of 30 V is simulated to obtain an output of 400 V with 400 W. Simulation Parameters of the proposed converter are depicted in Table 1.

Table 1 Proposed converter parameters

Components	Parameter
Input voltage	30 V
Output voltage	400 V
Input current	15.2 A
Output current	1 A
Inductor L_1, L_2	205, 180 μ H
Capacitor C_1, C_2, C_4	2.2 μ F
Capacitor C_3	2.2 μ F
Capacitor C_0	40 μ F

Resistor

400 Ω

A comparison with the conventional converters shows that the efficiency of the proposed converter is good and it is well suited for a high-voltage gain conversion scheme. The principal advantage of the converter is that it has lesser conduction and switching loss, reduced number of switches, and reduced size of the converter. The ripple voltage and current in proposed converter is less compared to other conventional converters. The proposed converter is well suited for inverter processes for converting DC sources to AC.

3.1. Simulative analysis of the proposed converter

The proposed converter is simulated in MATLAB and results are depicted as below.

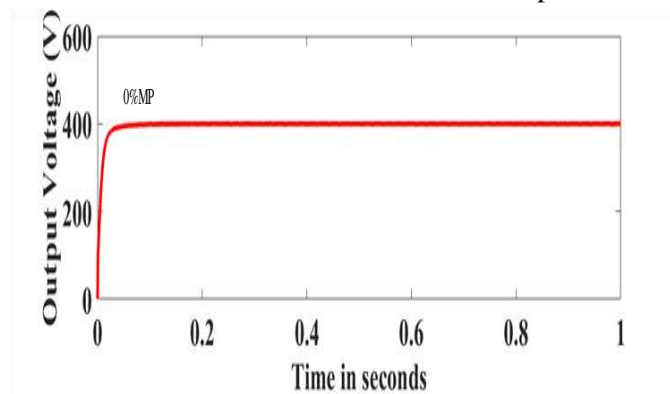

Fig. 3 Output voltage (V_o) of proposed converter

As seen in Fig. 3, the output voltage attained from the proposed converter is lower in ripple, the maximum over shoot is 0.1%, the settling time is 0.5ms, and the steady state error is 0.6%. This output suggests that the converter is operating in a stable state. The output current is depicted in Fig. 4. It can be noted that the output current is disturbance-free and it is constant, which helps the converter to be in a steady state. In Fig.5 the inductor current, capacitor voltage and diode voltage is depicted.

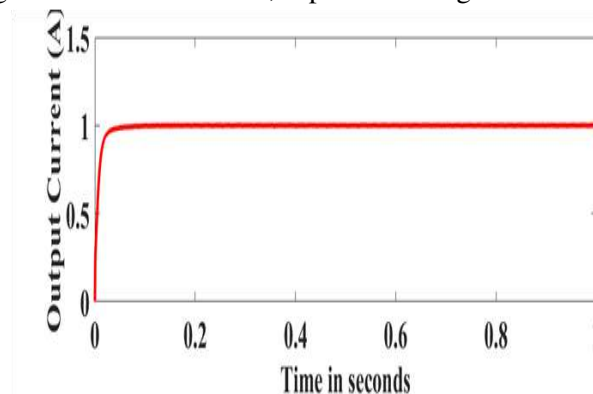

Figure. 4 Output current (I_o) of proposed converter

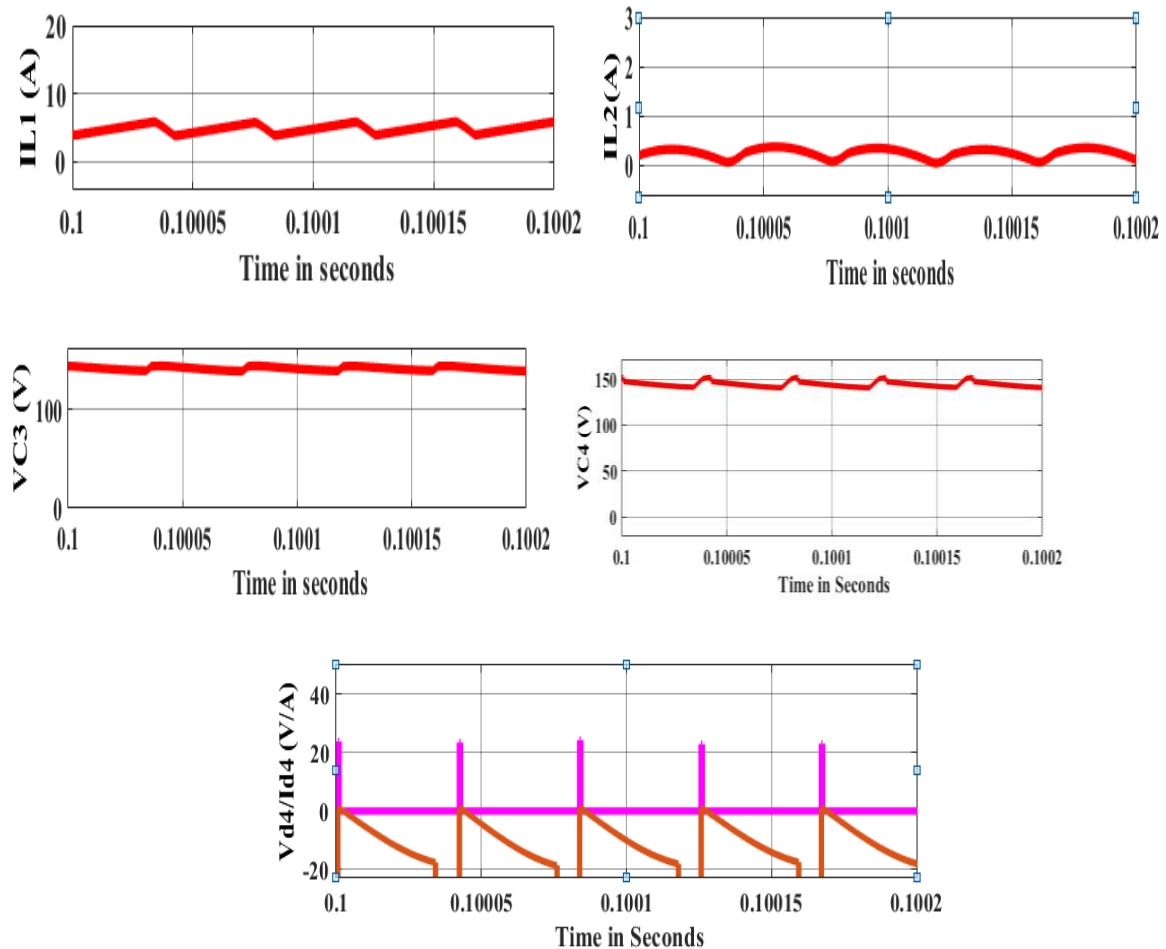

Figure .5a) Inductor current, b) capacitor voltage and c) diode voltage of the proposed converter

4. Disturbance analysis

4.1. Load Disturbance

The Proposed converter is tested under load disturbances such as at 10W, 20W to 100W .As the load is disturbed the converter is stable and provides the stable output even under disturbances. The fig 6 shows the stability of the converter even under different load disturbance. When the load is disturbed, the converter currents and output voltage slightly varies and attains stability at different load conditions. The hardware set up is depicted in fig.10

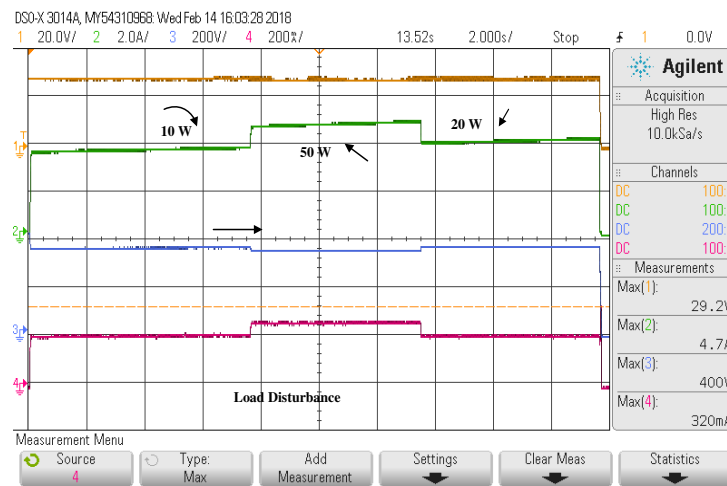

Figure.6 Load disturbance

4.2. Line Disturbance

Under Line disturbance, the input voltage is disturbed and it's not uniform as 30 V. The input voltage was disturbed as 28V, 32V etc. Even under different line disturbance condition the output voltage is maintained stable and constant. The fig 7 shows the line disturbance and stability of the system.

4.3. Line and Load Disturbance

As of next step, the proposed converter is tested under both line and load disturbance together. When load and line are disturbed together, the converter maintains stability with stable output. Hence under Dynamic conditions the converter is stable and it is verified experimentally. The fig.8 represents the converter stability under different load and line disturbances.

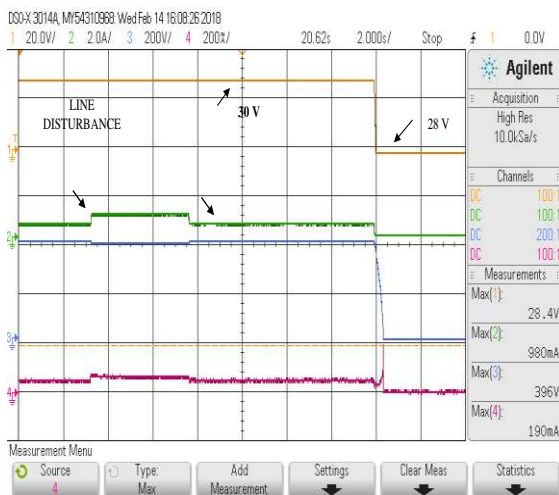

Figure.7 Line Disturbance

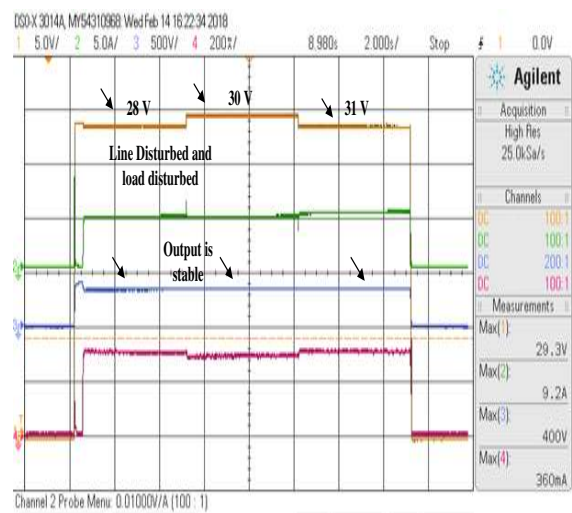

Figure.8 Line and Load disturbance

4.4. Efficiency of the proposed converter

The proposed converter attains an efficiency of 97.3% and it has been tested experimentally. The fig.9 shows the experimental analysis of efficiency of the proposed converter. Hence the proposed converter is highly stable and it suits for PV application. The proposed converter has fulfilled the needs such as high efficiency with reduced duty cycle and reduced ripple levels. All these needs are fulfilled by the proposed converter and it's proved and tested experimentally.

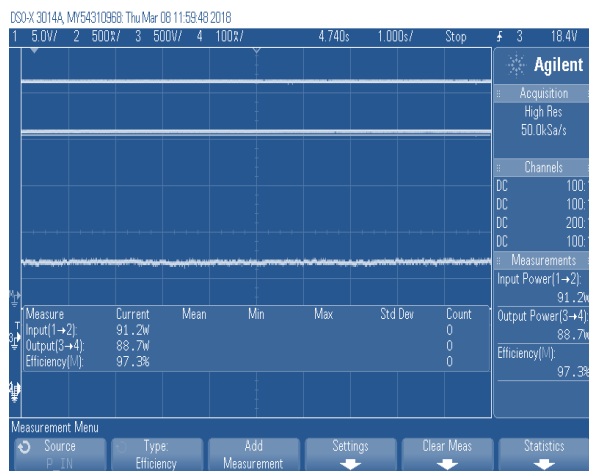
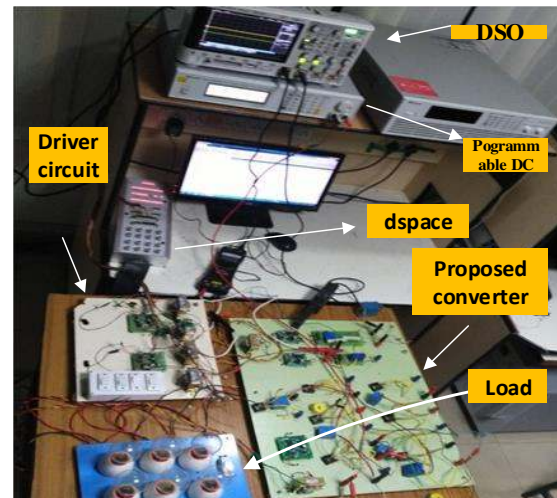

Figure.9 Efficiency of the proposed converter



Figuer.10 Hardware Prototype

5. Conclusion

A high step-up voltage gain modified SEPIC converter is proposed in this paper. The working and operation of the proposed converter in CCM mode is explained. The simulation analysis of the proposed converter is presented. A prototype was developed in the laboratory and its performance verified. The experimental results prove that the proposed converter attains a high stepping up of voltage (up to three times) with an efficiency of 97% and reduced switching stress. Also the disturbance analysis of the proposed converter is detailed.

6. References

- [1] Arunkumari, T. and Indragandhi, V., An overview of high voltage conversion ratio DC-DC converter configurations used in DC micro-grid architectures. *Renewable and Sustainable Energy Reviews*, 77, pp.670-687, Sep 2017.
- [2] Blaabjerg, F. and Ma, K., Future on power electronics for wind turbine systems. *IEEE Journal of Emerging and Selected Topics in Power Electronics*, 1(3), pp.139-152, Sep 2013.
- [3] Saravanan, S. and Babu, N.R., 2017. Analysis and implementation of high step-up DC-DC converter for PV based grid application. *Applied Energy*, 190, pp.64-72.
- [4] Kazimierczuk, M.K., *Pulse-width modulated DC-DC power converters*. John Wiley & Sons.
- [5] Lai, J.S., 2009. Power conditioning circuit topologies. *IEEE Industrial Electronics Magazine*, 3(2), Aug 2015.
- [6] Calais, M., Myrzik, J., Spooner, T. and Agelidis, V.G., Inverters for single-phase grid connected photovoltaic systems-an overview. In *Power Electronics Specialists Conference, 2002. pesc 02. 2002 IEEE 33rd Annual* (Vol. 4, pp. 1995-2000), 2002 IEEE.
- [7] Liang, T.J., Chen, S.M., Yang, L.S., Chen, J.F. and Ioinovici, A., Ultra-large gain step-up switched-capacitor DC-DC converter with coupled inductor for alternative sources of energy. *IEEE Transactions on Circuits and Systems I: Regular Papers*, 59(4), pp.864-874, April 2012
- [8] Gules, R., Dos Santos, W.M., Dos Reis, F.A., Romaneli, E.F.R. and Badin, A.A., A modified SEPIC converter with high static gain for renewable applications. *IEEE transactions on power electronics*, 29(11), pp.5860-5871, Nov 2014.
- [9] Hu, X. and Gong, C., A high voltage gain DC-DC converter integrating coupled-inductor and diode-capacitor techniques. *IEEE transactions on power electronics*, 29(2), pp.789-800, Feb 2014.
- [10] Changchien, S.K., Liang, T.J., Chen, J.F. and Yang, L.S., Step-up DC-DC converter by coupled inductor and voltage-lift technique. *IET power electronics*, 3(3), pp.369-378 May 2010.

- [11] Freitas, A.A.A., Tofoli, F.L., Júnior, E.M.S., Daher, S. and Antunes, F.L.M., High-voltage gain dc–dc boost converter with coupled inductors for photovoltaic systems. *IET Power Electronics*, 8(10), pp.1885-1892, June 2015.
- [12] Khalilzadeh, M. and Abbaszadeh, K., Non-isolated high step-up DC–DC converter based on coupled inductor with reduced voltage stress. *IET Power Electronics*, 8(11), pp.2184-2194, Nov 2015.
- [13] Wu, G., Ruan, X. and Ye, Z., Nonisolated high step-up DC–DC converters adopting switched-capacitor cell. *IEEE Transactions on Industrial Electronics*, 62(1), pp.383-393 Jan 2015.
- [14] Poorali, B., Torkan, A. and Adib, E., High step-up Z-source DC–DC converter with coupled inductors and switched capacitor cell. *IET Power Electronics*, 8(8), pp.1394-1402, Apr 2015.
- [15] Kwon, J.M., Choi, W.Y., Lee, J.J., Kim, E.H. and Kwon, B.H., Continuous-conduction-mode SEPIC converter with low reverse-recovery loss for power factor correction. *IEE Proceedings-Electric Power Applications*, 153(5), pp.673-681. Sep 2006.
- [16] Zhu, M. and Luo, F.L., Series SEPIC implementing voltage-lift technique for DC–DC power conversion. *IET Power Electronics*, 1(1), pp.109-121, Mar 2008.
- [17] Al-Saffar, M.A., Ismail, E.H., Sabzali, A.J. and Fardoun, A.A., An improved topology of SEPIC converter with reduced output voltage ripple. *IEEE Transactions on Power Electronics*, 23(5), pp.2377-2386, Sep 2008.
- [18] deMelo, P.F., Gules, R., Romaneli, E.F.R. and Annunziato, R.C., A modified SEPIC converter for high-power-factor rectifier and universal input voltage applications. *IEEE Transactions on Power Electronics*, 25(2), pp.310-321, Feb 2010.
- [19] Park, K.B., Moon, G.W. and Youn, M.J., Nonisolated high step-up boost converter integrated with sepic converter. *IEEE Transactions on Power Electronics*, 25(9), pp.2266-2275, Sep 2010.
- [20] Rosas-Caro, J.C., Mayo-Maldonado, J.C., Valdez-Resendiz, J.E., Salas-Cabrera, R., González-Rodríguez, A., Salas-Cabrera, E.N., Cisneros-Villegas, H. and Gonzalez-Hernandez, J.G., Multiplier SEPIC converter. In *Electrical Communications and Computers (CONIELECOMP), 2011 21st International Conference on* (pp. 232-238). IEEE. Feb 2011.
- [21] Middlebrook, R.D., California Institute of Technology., *Transformerless dc-to-dc converters with large conversion ratios*. U.S. Patent 4,654,769 Nov 1984.
- [22] Hu, J., Sagneri, A.D., Rivas, J.M., Han, Y., Davis, S.M. and Perreault, D.J., High-frequency resonant SEPIC converter with wide input and output voltage ranges. *IEEE Transactions on Power Electronics*, 27(1), pp.189-200, Jan 2012.
- [23] Zhu, M. and Luo, F.L., 2007, May. Implementing of developed voltage lift technique on SEPIC, Cuk and double-output DC-DC converters. In *Industrial Electronics and Applications, ICIEA 2007. 2nd IEEE Conference on* (pp. 674-681). IEEE, ay 2007.
- [24] Han, Y. and Perreault, D.J., Analysis and design of high efficiency matching networks. *IEEE Transactions on Power Electronics*, 21(5), pp.1484-1491 Sep 2006.
- [25] Arunkumari, T. and Indragandhi, V., 2018. A NOVEL SINGLE SWITCH HIGH STEP UP DC-DC CONVERTER FOR PV BASED APPLICATION. *International Journal of Renewable Energy Research (IJRER)*, 8(2), pp.1085-1097.
- [26] Rosas-Caro, J.C., Sanchez, V.M., Vazquez-Bautista, R.F., Morales-Mendoza, L.J., Mayo-Maldonado, J.C., Garcia-Vite, P.M. and Barbosa, R., 2016. A novel DC-DC multilevel SEPIC converter for PEMFC systems. *International Journal of Hydrogen Energy*, 41(48), pp.23401-23408.