

Implementation of lean manufacturing and lean audit system in an auto parts manufacturing industry – an industrial case study

Article (Accepted Version)

Dhiravidamani, P, Ramkumar, A S, Ponnambalam, S G and Subramanian, Nachiappan (2018) Implementation of lean manufacturing and lean audit system in an auto parts manufacturing industry – an industrial case study. *International Journal of Computer Integrated Manufacturing*, 31 (6). pp. 579-594. ISSN 0951-192X

This version is available from Sussex Research Online: <http://sro.sussex.ac.uk/id/eprint/69704/>

This document is made available in accordance with publisher policies and may differ from the published version or from the version of record. If you wish to cite this item you are advised to consult the publisher's version. Please see the URL above for details on accessing the published version.

Copyright and reuse:

Sussex Research Online is a digital repository of the research output of the University.

Copyright and all moral rights to the version of the paper presented here belong to the individual author(s) and/or other copyright owners. To the extent reasonable and practicable, the material made available in SRO has been checked for eligibility before being made available.

Copies of full text items generally can be reproduced, displayed or performed and given to third parties in any format or medium for personal research or study, educational, or not-for-profit purposes without prior permission or charge, provided that the authors, title and full bibliographic details are credited, a hyperlink and/or URL is given for the original metadata page and the content is not changed in any way.

Lean Manufacturing Process Implementation in an Auto Parts Manufacturing Industry – An Industrial Case Study

Abstract

Lean manufacturing is one of the innovative manufacturing concepts being applied in many industries to avoid the wastages of resources and improving the quality of products and help the company to become more effective and productive. It also focuses on continuous improvements with the total involvement of all employees with optimum utilization of man power and machine by reducing idle time and reducing lead time with help of lean tools like value stream mapping and kaizen. This paper presents a case study carried out in a foundry division of an auto parts manufacturing industry, where lean tools are implemented for the defect reduction and productivity improvement. In this paper, a conceptualized implementation of total productive maintenance practices of lean tools: Kaizen or continuous improvement and value stream map in an auto parts industry are presented. The result shows improved performance in terms of average core rejections, sand leakage and air lock problem.

Key words: Kaizen continuous improvement, Lean manufacturing, Takt time, Total productive maintenance and Value stream map.

1. Introduction

Lean manufacturing or lean production is a systematic method for the elimination of waste within a manufacturing process. T.Ward [1] advocate lean production as a multi-dimensional approach that encompasses a wide variety of management practices, including just-in-time, quality systems, work teams, cellular manufacturing, supplier management, etc, in an integrated system. The core thrust of lean production is that produces final products at the face of customer demand with little or no waste. After World War II, Japanese manufacturers, particularly in the automotive industry, were faced with the problem of shortages of material, financial, and human resources. Eiji Toyoda (Managing Director & Chairman, 1950-1994, Toyota Corporation) and Taiichi Ohno (Father of Kanban system) at the Toyota Motor Company in Japan initiated the concept of the Toyota Production System, or what is known as lean manufacturing. Quickly following the success of lean manufacturing in Japan, other companies and industries, particularly in the US, had started implemented lean. Lean operating principles in manufacturing environments are known as; Lean Manufacturing, Lean Production, Toyota Production System, etc. Henry Ford had been using parts of Lean as early as 1920's [2], and he stated that: "One of the most noteworthy accomplishments in keeping the price of Ford products low is the gradual shortening of the production cycle. The longer an article is in the process of manufacture and the more it is moved about, the greater is its ultimate cost." The definition of Lean, as developed by The National Institute of Standards and Technology Manufacturing Extension Partnership's Lean Network defined lean manufacturing as, lean manufacturing is systematic approach of identifying and eliminating waste through continuous improvement, flow the product at the pull of the customer in pursuit of perfection'[3]. The objective of this work to identify and give the practical suggestions for carrying out important maintenance activities with an aim to reduce the lead time and to avoid the core rejections. Lean manufacturing is a systematic approach to eliminate waste from all aspects of an organization's operations, where waste is viewed as any use or loss of resources that does not add value to the product or service for which customer wants to pay. In lean, seven types of wastes are considered: Overproduction, Inventory, Waiting, Motion, Correction, Over processing and Transportation.

In many industrial processes, such non-value added activity can comprise more than 90% of a factory's total activity. The objective of lean manufacturing is to achieve faster production flow and in more predictable manner and to eliminate waste thereby permitting better wages for workers, higher profit for owners and better quality for customer. Lean

manufacturing is more often used with the terms like benefits; cost reduction, lead-time reduction etc. lean manufacturing is an operational system that maximizes value added, and reduces or eliminates waste in all processes throughout the value stream.

New market regulation throughout the world forcing the countries to open their markets to global competition. In this scenario, not only manufacturing organizations but also service sectors have to improve their performance to face the stiff global competition and survive. To conquer these hardships, new philosophies are being developed since the last two to three decades. One of the prominent concepts namely, Total Productive Maintenance (TPM) is equally useful for manufacturing and service sectors to improve their performances in lean manufacturing environment. The goal of TPM is to drive all waste to zero, zero accidents, zero defects and zero breakdowns. Competition means different things to different people. It is important to understand that a TPM implementation emphasizes greatly on people and that requires cultural change from all different people group within the organization. Implementing TPM procedures and measuring the results will take long time. TPM is “All of the strategies needed to sustain a healthy maintenance log” [4]. A full definition of TPM contains the following five points [5]:

1. TPM strives for maximum equipment effectiveness.
2. TPM establishes a total system of Preventive maintenance for the entire life of the equipment.
3. TPM includes participation by all sectors of the organization that plan, use, and maintain equipment.
4. TPM participation is from top management to the frontline staff.
5. Execution of TPM is based on small Group Activity.

Highlighting the cost benefits and getting approval from the management is difficult in most of the organization due to deployment of the practices of lean manufacturing policies. This paper addresses the application of lean manufacturing practices and concepts to the foundry division of an auto parts manufacturing industry. The present work focuses on implementation of small group Kobetsu Kaizen technique and Value Stream Mapping (VSM). Kobetsu Kaizen is one of the eight pillars of TPM [6] and it is a powerful engine for improvement and it requires methodological investigations of a problem.

2. Literature review

Askin and Goldberg [7], advocate that understanding the basics of production systems for planning, scheduling and controlling production quantities and timing has long been a fundamental curricular goal in both industrial engineering and management program. The global industry in 21st century has forced most of the leaders in several sectors to implement more competitive manufacturing system. The best answer as found in the literature is lean one of the eight pillars of TPM [6] and it is manufacturing. Initially it is started at Toyota plant, Japan, which is known as Toyota Production System (TPS). It has been widely known and implemented since 1960. As far as TPM is concerned, general theories have been discussed in most of the manufacturing area [8]. Over the past two decades, lot of research focuses on the implementation of practices of TPM and behavior of industry environment. TPM was developed during 1970s [9], and it became popular among manufacturing professional only after late 1980s. Even though the basic concept of TPM is a form of productive maintenance involving all employees [10], the type of implementation practices varies depending on the characteristics of the industry and was implemented increasingly by production, assembly, fabrication and processing industries.

According to Rinehart et al. [11], lean manufacturing will be the standard manufacturing mode of the 21st century. There is no alternative to lean manufacturing proposed by Dankbaar[12]. Theoretically, Lean Manufacturing can be applied to all industries as proved in [13]. Meier and Forrester [14] found lean manufacturing was successfully implemented in the tableware industry. This system is comprised of universal set management principles which could be implemented anywhere and in any company [13]. Therefore, small and medium scale enterprises have been encouraged to apply the lean concepts [13, 15, 16]. It is now widely recognized that organizations that have mastered lean manufacturing methods have substantial cost and quality advantages over those who still practicing traditional mass production [17]. A frame work has been developed for sustainable Lean implementation by JadhavJR, Mantha SS and Santhos RB [18]. Lean manufacturing combines the best features of both mass production and craft production, the ability to reduce costs per unit and dramatically improve quality while at the same time providing an ever wider range of products and more challenging work [13]. A survey has been conducted to identify the status of Lean practices in the machine tool manufacturing industries to address the problems and suitable measure have been suggested by Eswaramoorthi et al [19]. The goal of lean manufacturing is to reduce the waste in human effort, inventory, time to market and manufacturing space to become highly responsive to

customer demand while producing world-class quality products in the most efficient and economical manner [15]. As it had been published by earlier researchers and practitioners, lean manufacturing has been implemented successfully in many large organizations but there is still less documented evidence of its implementation in smaller organizations [16]. The increasing demand for high quality products and highly capable business processes by large organization has left no choice on the SMEs to consider Lean Manufacturing. A road map has been developed for Lean implementation in Indian auto component industry for sustainable Lean implementation by Jadhav JR, Mantha SS and Rane SB [20].

Value stream refers to those specifics of the firms that add value to the product or service under consideration and it is necessary to map both inter- and intra-company value-adding streams [15]. The rate at which value is added to a single product from the raw material stage through dispatch and delivery to the customer and changing view of organizations towards improvement to processes is discussed by Barker [21]. A new scheme of classifying operations into three generic categories as non-value adding (NVA), necessary but non-value adding and value adding are suggested and this scheme proved to be more generic and was extended to different areas analyzed by Mondeo [22]. Individual tools to understand different value streams maps and regarding their overlapping nature and use were developed by Jessop and Jones [23]. Braglia et al. [24] pointed out that Value Stream Mapping (VSM) is basically a paper-and-pencil-based technique, so, the accuracy level is limited, and the number of versions that can be handled is low; in real situations, many companies are of a “high variety–low volume type”, this requires many value streams and cannot be addressed by simple VSM. The application of value stream mapping, in order to identify the various forms of waste to a dedicated in a production flow line is studied by Shoo et al [25]. The literature review indicates that considerable amount of research has been carried out extending the lean concepts for ensuring the productivity improvement. The present work focuses on the second pillar of TPM namely, Kobetsu – Kaizen and value stream mapping by implementing these two lean tools in a core shop of a foundry producing automobile parts.

2.1 Review on implementation of Kaizen

The philosophy of Kaizen has kindled considerable interest among researchers because it increases productivity of the company and helps to produce high-quality products with minimum efforts. According to Masaaki [26], Kaizen is a continuous improvement process involving everyone, managers and workers alike. Broadly defined, Kaizen is a strategy to include concepts, systems and tools within the bigger picture of leadership involving and

people culture, all driven by the customer. Wickens [27] stressed the contribution of teamwork to make the concept of Kaizen. Nihon HR Kyokai [28] described that Kaizen is more than just a means of improvement because it represents the daily struggles occurring in the workplace and the manner in which these struggles are overcome. Kaizen can be applied to any area in need of improvement. Radharamanan et al. [29] apply Kaizen technique to a small-sized custom-made furniture industry. The main aim of their work is to develop the product with higher quality, lower cost and higher productivity to meet customer requirements. Chen et al. [30] applied Kaizen approach for designing a cellular system. The focus of their paper was the virtual manufacture of meat tenderizer. Lee [31] has conducted a case study at Nichols Foods manufacturing food products. There was a lack of standard operating procedures, forces and structure. The study described how the company values have improved the work environment for the employees and motivated them to achieve excellence. Amarjeet Gupth et al. [36] found many of the core rejections take place in manual core making process and this affects the productivity of core shop. According to Rajesh Rajkolhe, Khan J. G [37] has different castings defects are studied with various quality control dept in various industries and it is helpful for improving productivity. This section reviewed the Kaizen literature which explains the performance improvement of systems on implementation of Kaizen. In this paper, Kaizen concept is implemented in a phased manner in a core shop of a company for continuous improvement.

3. Problem environment

Minimizing core rejections in a core shop of a foundry is complex and to arrive at a solution which yields a good performance is a tedious task. The approach adopted in this paper is to implement Kobetsu-Kaizen and analyze the core rejection problem by using the cause and effect analysis diagram. This paper aimed at reducing waste and optimum utilization of man power and machine by reducing idle time and reducing lead time by well organizing, finishing and inspection activity. The strategies proposed are, changes in material handling movement, layout redesign for material handling, converting offline activity into online such as finishing and inspection. The first step is to do time study for men and machine activity and also motion study for operator and thus improving ergonomics of operator. Studies are carried out from the process starting from raw material until packing so that non value adding activities are identified and reducing the lead time were reported and analyzed.

3. Case study

The study is conducted in core shop located in Sakthi Auto Component Ltd (SACE), Erode, TN, India for possible improvements through implementing Kobetsu -Kaizen. Presently, the SACE has a capacity to produce 24000 tons / annum of S.G iron castings on a 100 acre land with all amenities for workman and officers like housing, transport, etc. SACE is one of the major producers of S.G iron castings meeting the needs of most of the automotive and other general engineering industries. Supplying most critical components like steering knuckle, brake drums and manifold for all Suzuki Vehicles manufactures in India by M/S Maruti Udyog Limited, New Delhi. SACE is equipped with DISAMATIC FOUNDRY with the state of the art manufacturing technology which is regarded as the best anywhere in the equipped with many sophisticated special purpose and CNC machines to produce precision oriented component for passenger car and automobile industries. The company presently facing the problem of huge work- in-process and high core rejections due to failures of pressure, air lock, sand leakages and more broken cores. So, the management decided to implement lean principles in the foundry shop floor in a systematic manner. The present study is focused to illustrate the proposed methodology for implementing the lean tools in the shop floor.

3. 1 Core shop layout

The core shop in SACE consists of ten core shooting machines and it manufacture three different type of cores namely Model 'B' disc, LQ disc, LC1 disc. Fig.1 shows the core shop layout. The core shop having the following sections namely machine area, core oven, inspection, dressing, rejection and dispatch. The following processes are carried out in each core shooting machine such as core sand preparation, pouring the sand into die, heating, curing and core ejection. All the ejected cores are moved into core dressing area once dressing is over, all the finished components are waiting for inspection. The inspection was carried out in a separate place and all accepted items are stored in the rack which is available in front of each machine and waiting for hardening and yellow coating. The rejected core was taken away from the core shop and fed in to the rejected area as shown in Figure 1.

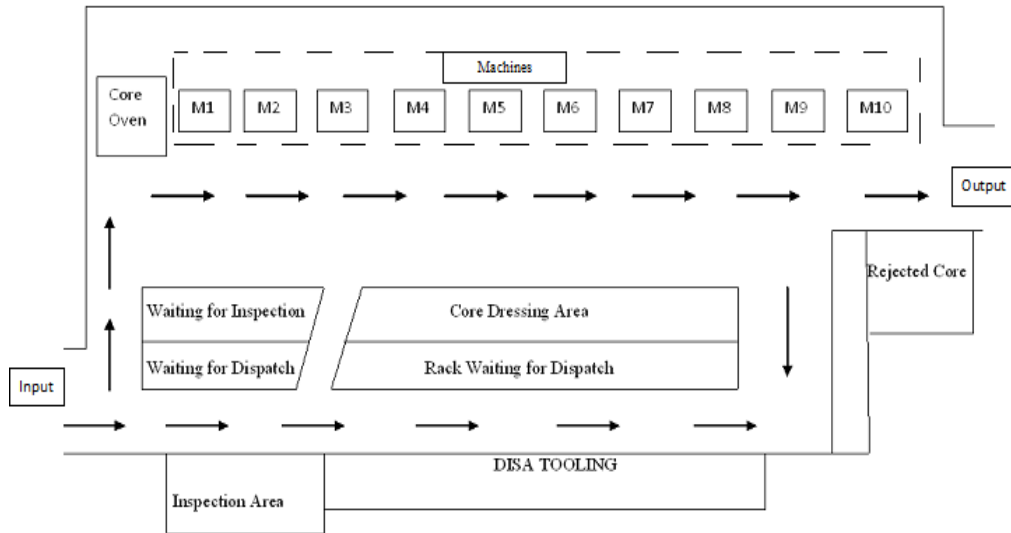

Figure 1. Core shop Layout

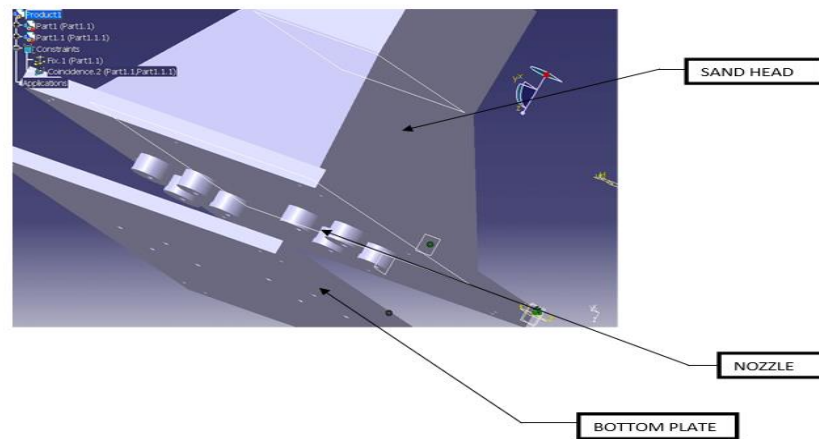

Figure 2. Existing arrangement of sand head hopper

3.2 Existing arrangement of Sand head with top and bottom plate

The CAD model from CATIA V5 of existing arrangement of sand head hopper in core shooting machine is shown in Figure 2. It consists of sand head hopper with top plate, nozzle and bottom plate. The nozzle is fixed in the top plate as shown in figure. While making the core, the core sand is poured from the sand head hopper through the nozzle hole and reaches the die. After pouring the sand, the die must be maintained with required temperature and cooled by cooling jacket. After few seconds the core was ejected from the die. The nozzle has the vital role in the core making process. It is fitted in the top plate of the sand head hopper by press fit. While preparing the core, the sand head with nozzle come downward and coincide

with the bottom plate. Now core sand was poured through the nozzle with specified pressure and reaches the die, which is located below the bottom plate. After maintaining specified temperature, it was cooled by cooling jacket. Finally the core was ejected from the die.

3.3 Problem in the core shooter machine

The three different model of cores are manufactured in the core shop machine namely, Model-B disc, LQ disc and LC1 Disc. Rejection of cores is there in the core shooter because of the following reasons (1) Air Lock, (2) Sand Leakage and (3) Core Broken. Figure 3 shows the sample rejected cores in the core shooter machine due to the above problem.

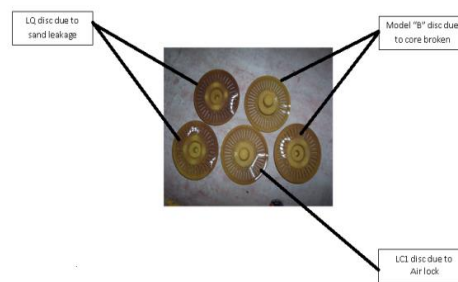

Figure 3. Sample of rejected cores

The six month rejection data is collected for the three core models namely Model “B” disc, LQ Disc, LC1 Disc and it is tabulated in Table 1.

Table 1. The rejection levels for the three cores for a period from July-2014 to Dec-2014

S. No	Month	Item	No of cores produced	Rejections				
				Air Lock	Sand Leakage	Core broken	Total	% of Rejection
1	July -14	Model “B” disc	14213	172	274	364	810	5.69
		LQ Disc	7781	259	152	191	602	7.73
		LC1 Disc	1986	70	74	77	221	11.12
2	Aug -14	Model “B” disc	11080	249	248	192	689	6.20
		LQ Disc	5404	120	123	119	362	6.69
		LC1 Disc	1042	15	13	14	42	4.0

3	Sep -14	Model "B" disc	13322	230	229	227	686	5.14
		LQ Disc	11586	270	268	269	807	6.96
		LC1 Disc	2216	36	18	51	105	4.73
4	Oct -14	Model "B" disc	16022	391	299	301	991	6.18
		LQ Disc	10278	190	188	192	570	5.54
		LC1 Disc	2525	62	61	63	186	7.36
5	Nov -14	Model "B" disc	11587	324	329	327	980	8.45
		LQ Disc	8152	191	188	192	571	7.0
		LC1 Disc	3690	87	86	89	262	7.10
6	Dec -14	Model "B" disc	8448	265	264	265	794	9.39
		LQ Disc	11554	192	194	190	576	4.98
		LC1 Disc	2108	41	23	31	95	4.50

Average Rejection = 6.59%

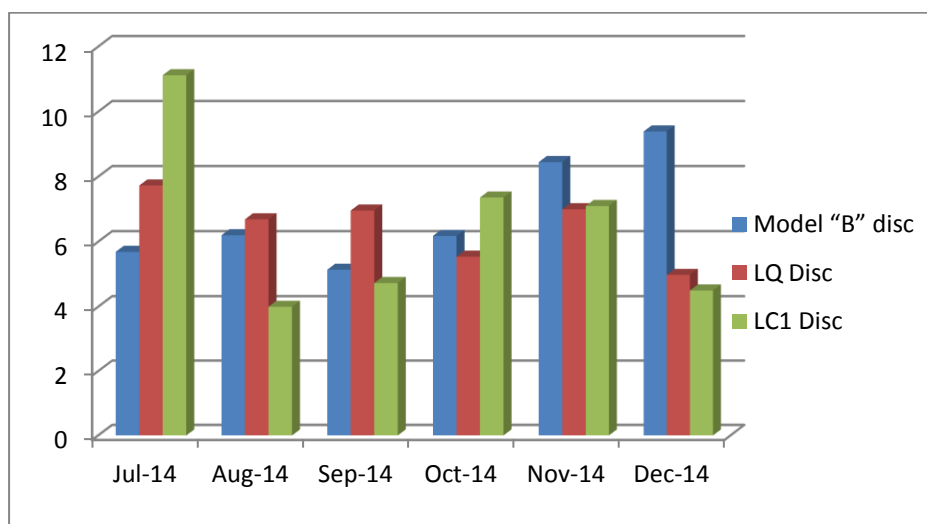

Figure 4. Rejection levels

Figure 4 shows the rejection level of each model and six month rejection data is mentioned in Table 1. The average core rejection is more than 6.59%.

4. Lean practices implemented

Kobetsu –Kaizen and value stream mapping are developed and implemented for the core shop in an automobile parts manufacturing industry. This paper addresses the application of lean practices in manufacturing of cores in a core shop of a foundry division and focuses on implementation of Kobetsu Kaizen technique and value stream map. A Cause and effect diagram is used for analyzing those problems and considered the parameters listed in Table 2. A future value stream map is to be prepared from the current state map for identifying and eliminating non-value added activities in each process.

4.1 Kobetsu- Kaizen steps for implementation of the proposed approach

Team Building is the ingredient that can make or break Kaizen events. It begins even before the event begins. Then during the events, it is the engine that runs the creativity that leads towards successful ideas, communication and implementation. After the event itself is over, it is the catalyst that helps transform an organization and promotes follow through and continuous improvement. Think about the situation for the facilitator, a small group of people are selected, some of whom may not have ever even met including the facilitator. The team may analyze the possible into lean metrics and also identify the environmental waste by visualize and execute for obtaining the objective for continuous improvement. They are put together and expected to come up with a solution to a problem and implement as much as possible. Then the same team of people is required to continue to work together with a small action item list to complete the objective and even further to improve it. With the consideration of these factors, the following steps are taken for the implementation of Kaizen of the proposed approach.

1. Team formation.
2. Ensure to management commitment and support.
3. Consider environmental metrics in addition to lean metrics.
4. Identify the environmental wastes in lean training.
5. Provide scope to visualize environmental wastes and eliminate.
6. Continue and sustain efforts.

Cause and effect diagram is an effective tool helps to visualize what is happening within production process and thus analyze data which helps direct the team towards a solution. It is also called a fishbone diagram. 4Ms Cause and effect diagram is created and employed in this

study. Based on the shop floor manager input, the 4Ms are Manpower, Methods, Machine and Materials.

- Man Power: The causes that can be attributed to the people working on the process.
- Methods: What is it about and how do conduct the operation than can cause the effect.
- Machines: The causes due to the machine or equipment.
- Materials: Potential causes due to materials.

The parameters of the existing system are listed in Table 2, as properties of sand, operating conditions, parallelism of top and bottom plate and impurities in the sand. By brainstorming, the possible causes for rejection of cores are sorted out in the core shooter machine and the points received from the discussion are: non- availability of proper weighing scale (Hand tools), work instructions, non value added activity during production , untrained manpower employment, under utilization of machines, equipment break down, unbalanced work allotment, improper method of loading and unloading, material shortage, non maintenance of 5S in production and cleaning area. Based on the shop floor people input, these factors are the main reasons for the air lock, sand leakage and broken cores. The cause and effect diagram is shown below in Figure 5. The predominant causes which are studied are listed as follows: 1. Man- Negligible in maintenance 2. Method- Doing as per the instructions 3. Parallelism checking- Bend in the bottom and top plates. These are shown in Figure 5.

Table 2 Cause and effect parameters

Parameters	Observation	Action Plan
Properties of sand	Variations in the core sand observed. Recommended mixture of sand, resin, oil, etc	The core sand is to be inspected as per the requirement.
Operating conditions	Visual inspection reveals the lack of core rejection	The operating conditions should be checked once in a week
Parallelism of top and bottom plate	Variations observed in both plates during sand blowing.	It should be adjusted if any

1	Jan -15	Model "B" disc	14500	181	294	176	651	4.48
		LQ Disc	6800	115	106	137	358	5.26
		LC1 Disc	1884	40	24	44	108	5.73
2	Feb-15	Model "B" disc	10600	208	216	186	610	5.75
		LQ Disc	4905	120	123	59	302	6.15
		LC1 Disc	961	15	9	4	28	2.91
3	Mar-15	Model "B" disc	14310	230	153	85	468	3.27
		LQ Disc	10690	270	158	269	697	6.52
		LC1 Disc	700	4	3	5	12	1.7
4	Apr – 15	Model "B" disc	12210	55	198	212	465	3.80
		LQ Disc	10400	202	210	40	452	4.34
		LC1 Disc	513	4	3	6	13	2.53
5	May- 15	Model "B" disc	13317	199	178	137	514	3.85
		LQ Disc	10245	240	181	77	497	4.85
		LC1 Disc	645	14	13	4	31	4.80
6	June- 15	Model "B" disc	12310	222	210	217	649	5.27
		LQ Disc	9982	232	248	229	709	7.10
		LC1 Disc	680	18	2	7	27	3.97

Average Rejection = 4.57 %

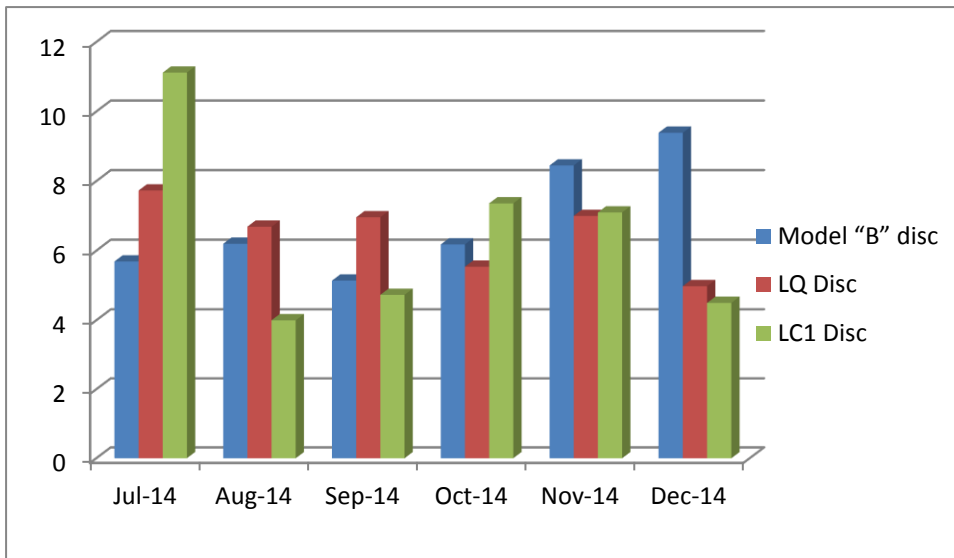

Figure 6. Rejection levels

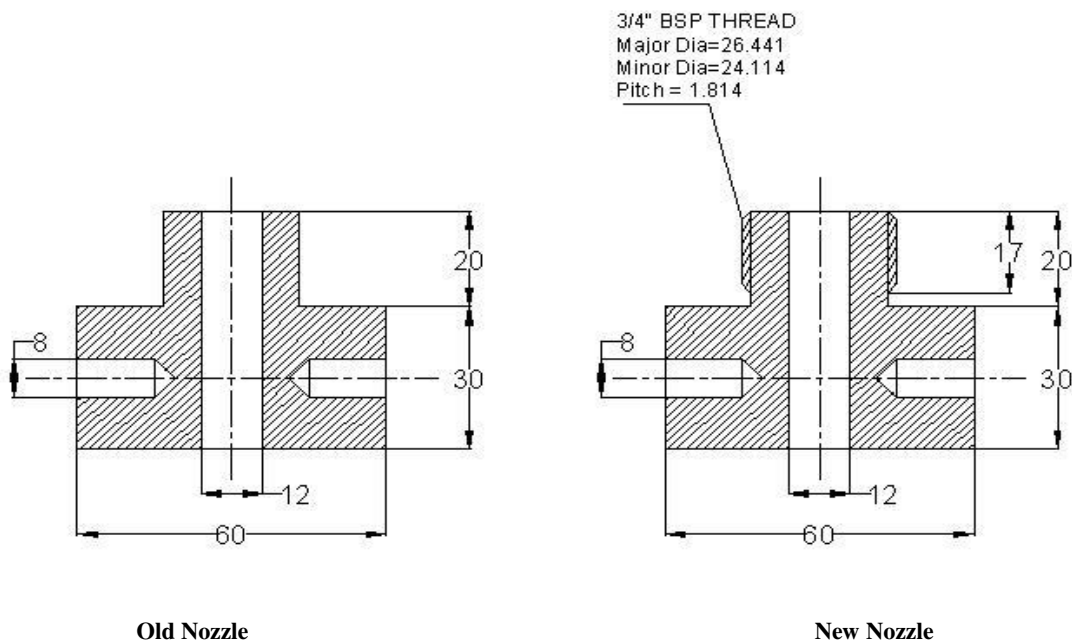

Figure 7. Old Nozzle and Threaded Nozzle

4.2 Implement improvements

The proposed improvement in nozzle by threading is implemented in the core shooting machine due to avoid more hot sand leakages, more air passes through the nozzle and also more butting stroke of nozzle plates. Due to above reasons, the cores are not meeting the requirements. Initially while core making, a hot box production method is carried out. The

details of the core shooting nozzles before and after the implementation are shown in Figure 7.

4.3 Check results

From the Figure 6, it can be observed that the rejection in the core is reduced in the new arrangement of threaded nozzle. The rejection in the core is considerably reduced by 2.02% (6.59% - 4.57%) average in the new threaded nozzle observed for a period of six month.

5. Cost analysis

5.1 Existing System

The cost analysis is based on per month production units. The observed datas are presented in Table 4. Number of cores produced 900 against average customer demand in a day considered for 27 working days per machine per month. The total core production is arrived a 24300 numbers and the existing cost Rs 15/- per core (industry data) is estimated for the total cost of Rs 364500/-. The core sand leakage is considered in kilogram and the cost of core sand is Rs 12/kg. The cost of core sand leakage and rejected cores are Rs 1944/- and Rs 21870/- (Rs 15/- per core) for a period of one month respectively.

Table 4 Costs for existing system

S. No	Description	Production Quantity per month	Cost in Rupees
1	Production cost of cores including labour, electricity, dressing, coating and inspection.	24300 nos	364500
2	Core sand leakage	162Kg (6 kg per day and for 27 days)	1944
3	Rejected cores	1602 nos (6.59% of rejection rate)	24030

5.2 New System

The average core rejection rate is obtained from the table 3 is 4.57%. Hence the core rejection improvement in the new system is 2.02%. So cost saved in the new system is nearly about Rs 2332.80/- and Rs 28836/- (including sand leakage and rejected cores for six month periods for ten machines).

5.3 Consolidated gain

The core rejection data are collected from the industry for a period of six months after implementation of the new nozzle in the core shooting machine. The advantage in the new system as the average core rejection is reduced by 2.02% (6.59% - 4.57%) average as clearly mentioned in the table 3 due to air lock, sand leakage and core broken. .

6. Value stream mapping

Lean Enterprise Research Centre, Cardiff, UK [32], concluded that, for a typical physical product environment, 5% of the total activities were value adding activities, 60% were non- value adding activities, and the remaining 35% are necessary but non- value adding activities. The value stream is nothing but the mapping of the all activities which are required for bringing the product from raw material to end customer. Value stream mapping is playing a very productive role in the entire lean process since it is stating current and future conditions when they develop plans to install lean systems [33, 34, 35]. Infinite attention should be given to establishing flow, eliminating waste, and eliminating non-value adding activity. Value stream mapping is used to visually map the flow of production. It shows the current and future state of processes in a way that highlights opportunities for improvement and also exposes

waste in the current processes and provides a roadmap for improvement through the future state. A value stream map shows the flow of materials and information, and categorizes activities into three segments: value enabling, value adding and non-value adding. Value stream mapping focuses on identifying and eliminating the non-value added activities in each process step and reducing the waiting time between consecutive steps wherever possible. Value enabling activities, are also important however, and cannot be totally eliminated from a system. So, they can be sub-classified into value adding and non-value adding activities, allowing those value enabling activities that are non-valued added to be eliminated. From the shop floor, it is observed the present core making process flow line contains the following value added and non- value adding activities:

- Sand blow, Sand feed, handling and are the non- value adding activities,
- Core slider valve, Sand convey, Curing, Dressing, Heat treatment and Inspection are the value adding activities.

6.1 Time Study

Time study is nothing but finding out the time taken for the activities. The time study will give us the standard time which is considered as a base for the project. The standard time is the reasonable time that an operator requires to perform a given task. Standard time also includes all allowances given to the operator. In this paper all the time study had been taken by stopwatch. Time study of all 10 machines, rework, inspection and preparation had taken. This time study helps in evaluating cycle time for each process and also helps in constructing value stream mapping. Time study provides the basis for calculating bottleneck operations.

6.2 Man-Machine Chart

It is a chart on which activities of workers, product and machines are recorded on a common time scale to show their relationships. The first step in eliminating unnecessary waiting time for the operator and for the machine is to record exactly when each activities works and what each activities does and such a record is called Man & Machine chart. In this chart operations consist of three main steps: (1) Get Ready, such as putting material in the machine; (2) Do (doing the work), performing the operations (3) Waiting for an operation to be completed or "Idle."Easily clearer picture of the relationship of the operator's working time and the machine time can be obtained by showing the information graphically to scale. Man-machine chart which is also known as worker-machine process chart and they are estimating most effective relationship between operator(s) and machine(s), i.e. minimum total percentage of idle time. With the help of time study, time taken for each activity had been calculated and

thus man time for different activity, total machine time and idle time for both man and machine had been plotted. Man activities are divided into loading, unloading, tear-trim operation, slug separation, idle time during one cycle. With the help of man-machine chart at the one glance whole machine process can be summarized, understood and it will help in developing further improvements.

6.3 Takt Time

Takt time aligns production with customer demand. It provides a simple, consistent and intuitive method of pacing production. Takt time is defined as total available time for production by customer demand. If takt time is usual to cycle time then there will be no delay in sending the order to customer and inventory will get reduce. The purpose of takt time is to precisely match production with demand. In other words, it is how fast you need to manufacture product in order to fulfill customer orders. Lean manufacturing takt time is calculated as, $Takt\ Time = (Planned\ Production\ Time) / (Customer\ Demand)$. Advantages of the use of takt time into manufacturing operations are steady and continuous flow of production, eliminate the overproduction by producing to actual customer demand, and set real-time targets for production that show operators exactly where their work output should be at any given point of time. Takt time is an important concept in lean manufacturing, matching actual production to customer demand. If cycle time of production is more than takt time results in overproduction and if cycle time of production is less than takt time results in delayed in fulfilling the customer orders.

Figure 8 illustrates the overall activities associated with a core shooting machine in core shop floor. Initially, the core die was prepared based on the requirement of the cores. Subsequently, various core making process are identified and the actual size of the core is calculated, taking into account the various allowances based on the experiences. Thereafter, the core sequences such as raw material inspection, mixing, hardening, shooting, heating, curing and core ejection are decided and performed. Succeeding operations like cleaning, dressing and coating are accomplished and if necessary, proper heat treatment is given. After pouring the raw material, the desired quality of the core was heated up to a specified temperature limit. After that it will be allowed for cooling and ejected the core from the die. In addition, testing and inspection are carried out to ascertain the desired quality. Finally finishing operations like cleaning, dressing, coating and inspection operations are performed to complete the process.

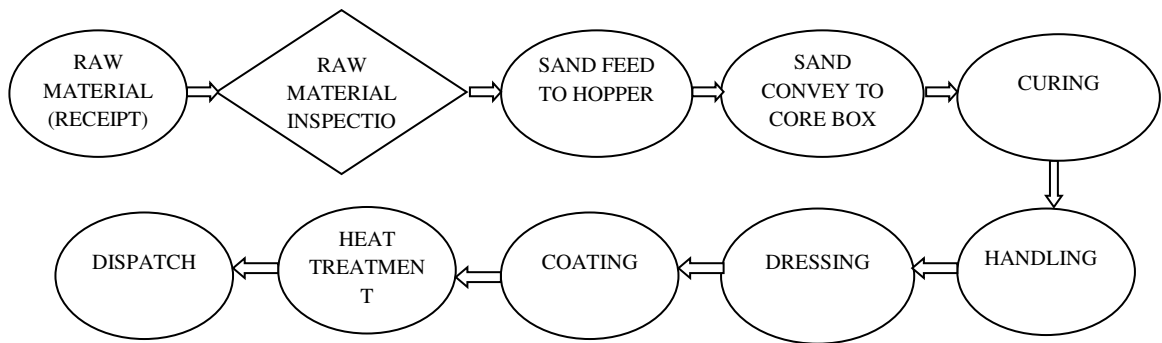













Figure. 8 Generic flow diagram for Horizontal shell shooter

Table 5 Generic icons to understanding value stream maps

	Supplier or Customer
	Work Station
	Information box
	Time box
	Inventory point
	Rework loop
	Station data box
	Physical flow
	Information flow
	Intercompany physical flow
	Production lead time & value added time

6.4 Constructing the present state value stream map

To construct the present value stream map, the relevant information is collected from the core shop floor. Table 5 summarizes the overall activities associated in the core shooting machine information related to the production line such as

run time at each machine, machine down time for each process, inventory storage points, cycle time, set up time, number of workers and operational hours also collected and documented properly. The present value stream map is constructed as shown in Fig. 9. A time line is added at the bottom of the map showing the lead time and value added time. run time at each machine, machine down time for each process, inventory storage points, cycle time, set up time, number of workers and operational hours also collected and documented properly. The present value stream map is constructed as shown in Figure 9. A time line is added at the bottom of the map showing the lead time and value added time.

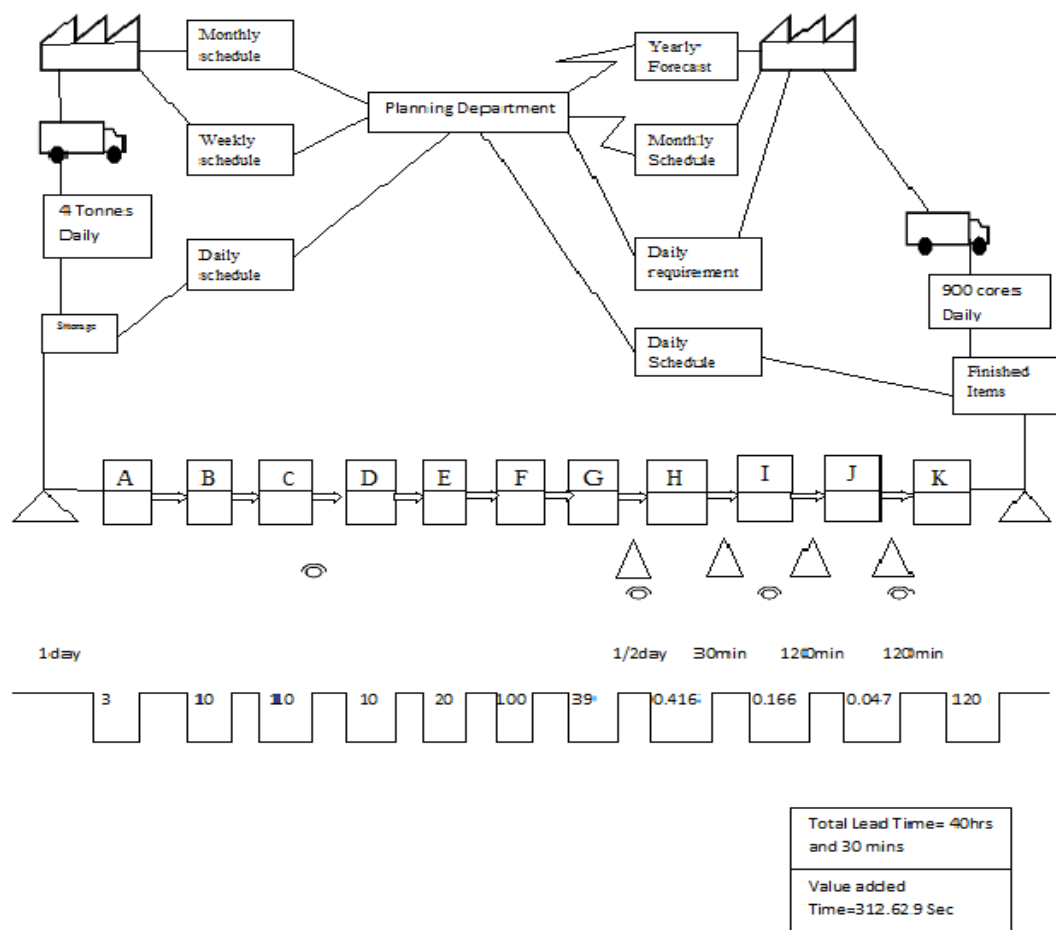

Figure. 9 Present value stream map

The various activities which are involved in the present value stream are noted and the associated the time of each activity are noted. Table 6 shows the details of the activities with time involved whether it adds value or not.

Table 6 Present value stream analysis report

S. No	Process	Process Name	Time in sec	Value added	No of operators
1	A	Sand Blow	3	No	1
2	B	Relief	10	No	
3	C	Sand feed	10	No	
4	D	Core slide valve	10	Yes	
5	E	Sand convey	20	Yes	
6	F	Curing	100	Yes	
7	G	Handling	39	No	
8	H	Dressing	0.416	Yes	3
9	I	Coating	0.166	No	5
10	J	Heat Treatment	0.047	Yes	5
11	K	Inspection	120	Yes	2
Total			312.629		16

Takt Time = Available effective working time / Customer demand

$$= 27 \times 22 \times 60 \times 60 / 24300$$

$$= 88 \text{sec}$$

Number of shifts per day = 3

Number of working days = 27

Available effective working time = 1320 min

Demand per month = 24300

Cycle time = 312.629 sec

Lead time = 40 hrs and 30min

6.5 Reducing set-up time

After the detailed study and analysis of standard routine sheet and through investigation on the shop floor, it was found that the set up time contributes significantly to reduce the production lead time. The set time of each machine is measured and listed in the table 7. The total set time of all the machines involved in the process is found to be approximately 71 mins. In order to reduce the total setup time, the various strategies such as problem identification,

data documentation, motion, time study, operation sheet review and continuous monitoring are adopted.

Table 7 Set-up time before and after improvement

S. No	Shooting Machine	Set-up time in min Before improvement	Set-up time in min After improvement
1	M-1	2	2
2	M-2	8	3
3	M-3	6	4
4	M-4	10	3
5	M-5	8	4
6	M-6	9	3
7	M-7	6	3
8	M-8	8	4
9	M-9	7	4
10	M-10	7	2
	Total set-up time	71 min	32 min

6.5.1 Initiatives taken

- Initially, a standard routine sheet is prepared for manpower and material movement.
- By improving layout, automated conveyor system for product movement and implementing 5S in storage and working place to facilitate quicker movement.
- Workplace monitoring is done and improvement opportunities are addressed in time. After implementing the above steps, the total set up time is reduced to 32min as in Table 7.

6.5.2 Constructing the future state value map

The future state value stream map is constructed as shown in Figure 10. The non value added activities which are observed and identified from Table 6. The following activities sand blow, relief, sand feed, handling and coating are considerably reduced.

Table 8. Future value stream analysis report

S. No	Process	Process Name	Time in sec	Value added	No of operators
1	A	Sand Blow	3	No	1
2	B	Relief	10	No	
3	C	Sand feed	10	No	
4	D	Core slide valve	10	Yes	
5	E	Sand convey	20	Yes	
6	F	Curing	100	Yes	
7	G	Handling	39	No	
8	H	Dressing	0.216	Yes	1
9	I	Coating	0.66	No	1
10	J	Heat Treatment	0.027	Yes	1
11	K	Inspection	60	Yes	1
Total			252.903		5

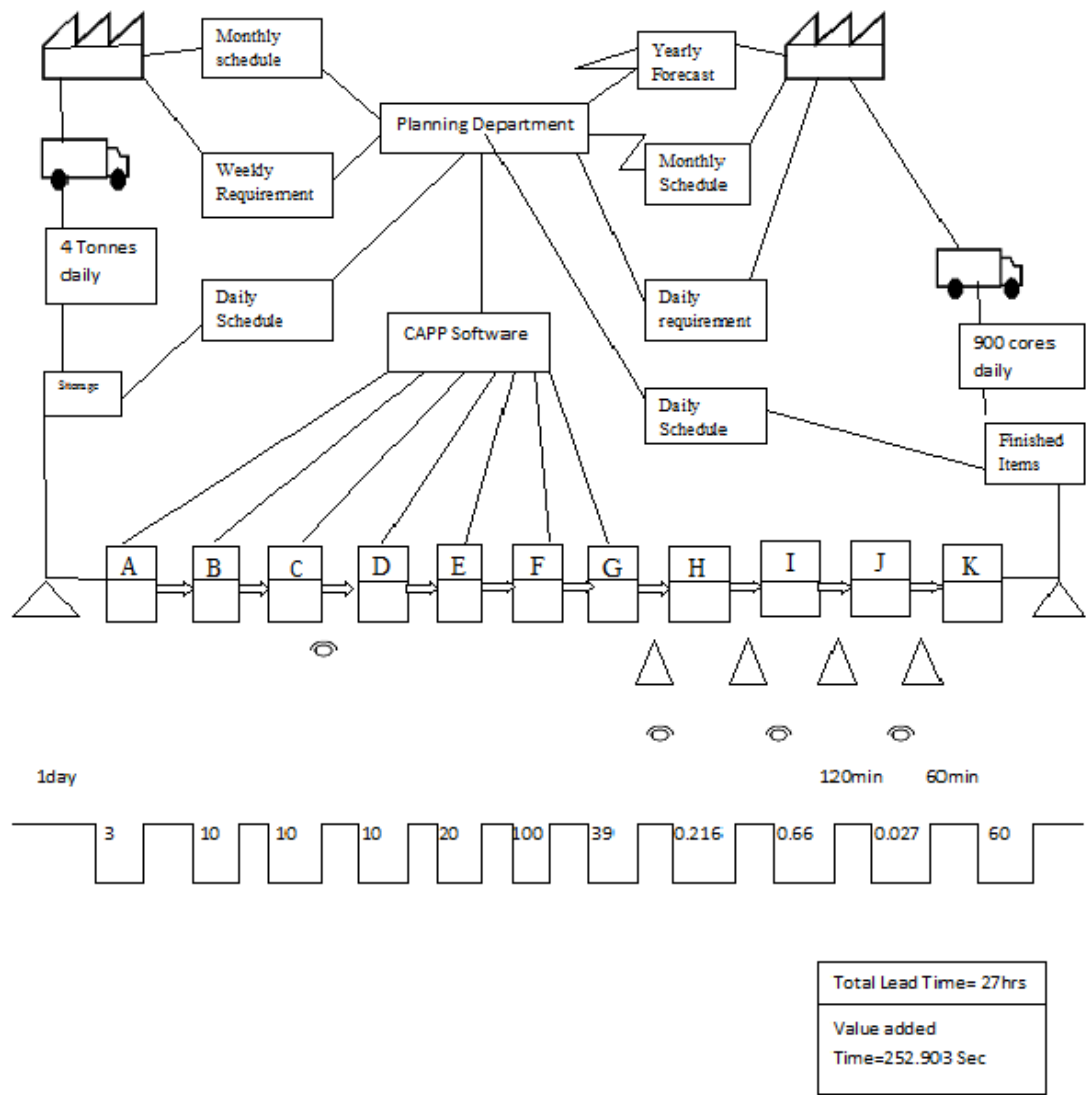

Figure. 10 Future stream map

Improved Estimates from VSM

Takt Time = Available effective working time / Customer demand

$$= 27 \times 22 \times 60 \times 60 / 24300$$

$$= 88 \text{sec}$$

Number of shifts per day = 3

Number of working days = 27

Available effective working time = 1320 min

Demand per month = 24300

Cycle time = 252.903 sec

Lead time = 27 hrs

A drastic reduction in WIP inventory is also observed. The production lead time is reduced to 27 hrs as compared to present state map and is found that the total lead time is reduced to 27 hrs as compared to present state map and percentage improvement of non value added activities were 60% achieved and illustrated in Figure 10. Table 8 shows the value stream analysis report for the future state.

6. 5. 3 Comparison of current state map and future state map

Table 9. Comparison report of current state and future state map

Variable	Before	After	Improvement
Lead Time(hrs)	40 and 30 mins	27	33.33%
C/ T NVA (sec / hrs)	312.629(5.2 hrs)	252.903(4.2 hrs)	60%
Setup time (min)	71	32	54.92%
Number of operators	16	5	31.25%

The percentage improvement for each variable when compared with present value stream map so there is near about 60% of non value added time is reduced and there by lead time is reduced by 33.33% and also the total set up time is reduced to 32min as mentioned in Table 9. The improvement is also illustrated in Figure 11.

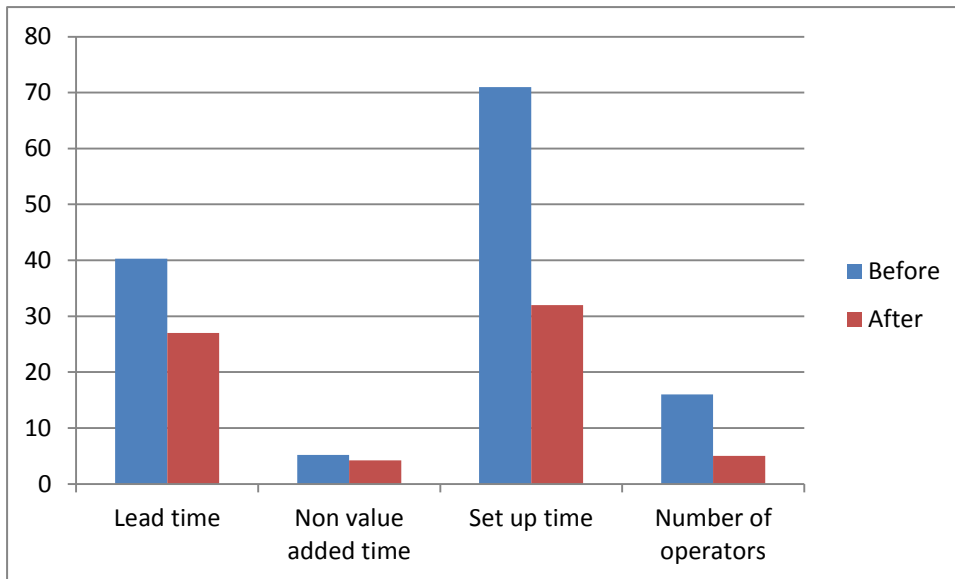

Figure. 11 Improvement before and after

7. Conclusion

In many foundry industries cores are manufactured by using manual core making process. Due to this Core rejection is more in case of manual core making process. This will affects on the productivity of core shop. So it is essential to improve the productivity of core shop by eliminating the different issues related to manual core making process. In this a paper a Lean manufacturing tools are implemented in a core shop at Sakthi Auto Components (P) Ltd. Kaizen concepts are used to identify the simple improvements which can be implemented without much expenses as well as design changes. The implementation of Kobetsu -Kaizen has yielded good improved results. From the implemented results in the case study it is found that the proposed system in the core shop reduce the rejection rate. The average core rejection is reduced by 2.02%. This paper also carries the advantage that of which by applying VSM tool to minimize the lead time, set up time and value added time in the core shop floor. The results of study shows 60% improvement in non value added activities in shop floor area per machine. So the Value stream mapping tool can be employed to reduce wastages and to improve the process.

References

1. Shah, R and Ward, PT (2003) Lean manufacturing: context, practice bundles, and performance, *Journal of Operation Management* 21(2), 129-149
2. Panizzolo, R, (1998) Applying the lessons learned from 27 lean manufacturers, The relevance of relationships management, *International Journal of Production Economics* 55(3): 223–240
3. Ohno. T, (1990) *Toyota Production system: Beyond large- Scale Production.*
4. Steinbacher,H.R and Steinbacher, LN, (1993) *TPM for America*, Productivity Press, Portland, US
5. Shirose K (1992), *TPM for workshop leaders*, Productivity Press, Portland, US
6. Bhadary, (2000), Management of Productivity through TPM, *Productivity* Vol. 41, No2, 240-251.
7. Askin, RG.and Goldberg, JB. (2005), *Design and analysis of lean production systems*, John Wiley, Singapore
8. JIPM(2002) *Kobetsu Kaizen Manual*, TPM Club, CII, India.
9. Ansuini JS (1995) *Improvement Engine*: Productivity Press, Portland, US
10. Suzuki T (1994) *TPM in Process Industries*, Productivity Press, Portland, US
11. Rinehart J. W, Huxlay C.V, Robertson, D. (1997) *Just another car factory? Lean production and its discontents*, Cornell University Press.
12. Dankbaar, B, (1997) Lean production: denial, confirmation or extension of socio technical systems design, *Human relations* 50(5):567-584
13. Womack, J,P, Jones, D.T, Roos, D, (1990) *The Machine that Changed the World*. Harper Perennial, New York.
14. Soriano-Meier, H. Forrester P. L, (2002) A model for evaluating the degree of leanness of manufacturing firms: *Integrated Manufacturing Systems* 13(2): 104-109
15. Womack JP, Jones DT (2010) *Lean Thinking: Banish Waste and Create Wealth in Your Corporation*, Simon and Schuster, New York.
16. Achanga P, Shehab E, Roy R, Nelder G (2006) Critical success factors for lean implementation within SMEs, *Journal of Manufacturing Technology Management* 17(4): 460-471
17. Pavnaskar SJ, Gershenson JK, Jambekar AB (2003) Classification scheme for lean manufacturing tools. *International Journal of Production Research* 41(13): 3075-3090

18. Jadhav JR, Mantha SS, Santhoshe Rane.B (2014), Development of frame work for sustainable lean implementation as ISM approach, J Ind Eng Int: 10:72
19. Eswaramoorthi M, Kathiresan GR, Prasad PSS, Mohanram PV (2011) A Survey on Lean Practices in Indian industries: International Journal of Advanced Manufacturing Technology, 52: 1091-1101
20. Jadhav JR, Mantha SS, Rane SB(2014), Road map for Lean implementation in Indian automotive component manufacturing industry: Comparative study of UNIDO model and ISM model, J Ind Eng Int: 11(2), 179-198
21. Barker RC (1994) The design of lean manufacturing systems using time-based analysis: International Journal of Operations and Production Management 14(11): 86-96
22. Mondeno Y (2011) Toyota Production System: an Integrated Approach to Just-in-Time, CRc Press
23. Jessop D, Jones O (1995) Value stream process modeling: a methodology for Creating competitive advantage: Proceedings of the 4th Annual IPSERA Conference, University of Birmingham, 46- 64
24. Braglia M, Carmignani G, Zammori F (2006) A new value stream mapping approach for complex production systems: International journal of production research 44(18-19): 3929-3952
25. Sahoo AK, Singh NK, Ravichandran, Tiwari MK (2008) Lean Philosophy: implementation in a forging company, International Journal of Advanced Manufacturing Technology 36(5-6): 451-462
26. Masaaki I (1986) Kaizen: The key to Japan's competitive success, McGraw-Hill, Irwin, New York
27. Wickens PD (1990) Production management: Japanese and British approaches. IEE Proceedings A (Physical Science, Measurement and Instrumentation, Management and Education)137(1): 52-54
28. Nihon HR, Kyokai (1992) Guiding Continuous Improvement through Employee Suggestions, (vol-2), Productivity Press, Portland, US
29. Radharamanan R, Godoy LP, Watanabe KI (1996) Quality and Productivity Improvement in a Custom-Made Furniture Industry Using Kaizen. Computer and Industrial Engineering 31(1/2): 471-474
30. Chen JC, Dugger J, Hammer B (2000) A Kaizen Based Approach for Cellular Manufacturing Design: A Case Study. The Journal of Technology Studies 27(2): 19-27

31. Lee M (2000) Customer Service Excellence Through people motivation and Kaizen, IEE Seminar, "Kaizen: from Understanding to Action" (Ref. No. 2000/035) 5: 1-21
32. Hines P, Taylor DH (2000) Going Lean: a guide to implementation, Lean Enterprise Research Centre, Cardiff Business School, Cardiff University, UK
33. Rother. M, Shook, J. (1999) Learning to see, Version 1.2 Brookline, MA: Lean Enterprise Institute.
34. Vegetaraman K, Vijaya Ramnath B, Muthukumar V, Elanchezian C (2014) Application of Value stream mapping for reduction cycle time in a Machining process. Procedia Material Science 6: 1187-1196
35. Goriwondo, W.M, Marecha A andMhkanga, S, (2011) Use of the value stream mapping tool for waste reduction in manufacturing, Case study for bread manufacturing in Zimbabwe, Proceedings of International Conference on Industrial Engineering and Operations Management, Kuala Lumpur, Malaysia: 236
36. Amarjeet Gupth R, Sanjay Aloni N, Rajkumar Binzade H (2016) A Review of on issues related to manual core making process in foundry industry, International journal of Scientific Research and Development 3(2): 467-478
37. Rajesh Rajlolhe, Khan J. G (2014) Defects, causes and their remedies in Casting process: A review, International Journal of research in Advent technology, 2(3): 817-827